

IMPROVEMENT OF SIMPLE AND REGENERATIVE GAS TURBINE USING SIMPLE AND EJECTOR-ABSORPTION REFRIGERATION

L. Garooci Farshi, S. M. Seyed Mahmoudi & A. H. Mosafa

Abstract: *The exhaust gases of gas turbine power plant carry a significant amount of thermal energy that is usually expelled to the atmosphere; this causes a reduction in net work and efficiency of gas turbine. On the other hand, the generated power and efficiency of gas turbine plants depend largely on the temperature of the inlet air, So that they both increase as the inlet air temperature decreases. The mentioned two problems can be solved by installing an absorption refrigeration cycle (ARC) at gas turbine inlet, working with thermal energy of exhaust gases. In this research, effect of inlet air cooling on gas turbine performance is studied. The work shows that, the net work and the efficiency will increase by 6-10% and 1-5% respectively for every 10°C decrease of inlet temperature. Since, coefficient of performance (COP) of ARC is low, with high pressure ratios in simple gas turbine (SGT) and with low pressure ratios in regenerative gas turbine (RGT), thermal energy of exhaust gases can not supply all the needed thermal energy for refrigeration cycle. The results show that, when an ejector is included in refrigeration cycle, the need for external energy source required for refrigeration cycle is reduced.*

Keywords: *Gas Turbine, Inlet Air Cooling, Absorption Refrigeration, Ejector, Regenerative Gas Turbine*

1. Introduction

Gas turbines are known to have a number of attractive features, principally: low capital cost, compact size, short delivery, high flexibility, fast starting and loading, lower manpower operating needs, not needing to water sources and better environmental performance, compared with other electricity producing devices specially the steam turbine. However, it suffers from relatively lower efficiency and strong influence of climate conditions specially temperature on its behavior. Also thermal energy of exhaust gases is delivered to and wasted in the environment. This low grade thermal energy can be put to beneficial use in a heat exchanger of RGT and/or generator of absorption refrigeration cycle to increase the power and efficiency of gas turbine plants.

In recent years, several researches have been carried out to enhance performance of gas turbine plants by using an ARC for inlet air cooling. J. Sigler et al [1] used an ammonia-water absorption machine for inlet cooling in a combined cycle and found out that implementation of inlet cooling using absorption chilling is an attractive option for plant power augmentation from an engineering and economic point of view.

E. Kakaras et al [2] present the possibilities and advantages from the integrated of an absorption air-cooling system with gas turbine to reduce the intake-air temperature. They concluded that at any location, the net output power can increase by at least 10%.

A.M. Bassily [3] introduced an absorption inlet-cooling system to the intercooled, reheat, recuperated gas-turbine cycle and showed that applying absorption inlet-cooling could increase the efficiency of the cycle by up to 6.6%. This increase was 3.9% when evaporative inlet cooling was utilized.

J. Wang and J.S. Chiou [4] considered an existing Frame 7B simple cycle gas turbine as the basic system and converted it into the modified system with either the inlet air cooling or/and steam injection features. They showed that, under the condition of local summer

Paper first received May, 10, 2007 and in revised form Nov. 02, 2009.

L. Garooci Farshi, is PhD student of Mechanical Engineering, Tabriz University. L.garoocifarshi@gmail.com

S.M. Seyed Mahmoudi is Assistant Prof. of Mechanical Engineering Department, Tabriz University. s_mahmoudi@tabrizu.ac.ir

A.H. Mosafa is PhD student of Mechanical Engineering, Tabriz University. amir.mosafa@gmail.com

weather, the benefits obtained from the system implementing both steam injection and inlet air cooling features are more than a 70% boost in power and 20.4% improvement in heat rate.

M. Ameri and S.H. Hejazi [5] presented an overview of an intake air-cooling system that uses an absorption chiller and an air cooler in the Chabahar power plant. They obtained that, by using this technique the output power will increase by 11.3%.

In another work E. Kakaras et al [6] presented a computer simulation of the integration of an innovative absorption chiller technology for reducing the intake-air temperature in simple gas turbine and a combined cycle plants. The air cooling system demonstrated a higher gain in power output and efficiency than evaporative cooling for a simple gas turbine, independent of ambient air temperature. The results for the combined cycle test case also demonstrated that the absorption chiller can considerably increase the power output, although there is an efficiency reduction.

B. Dawoud et al [7] evaluated the effect of several inlet air cooling techniques on gas-turbine power plants in two locations; namely, Marmul and Fahud, in Oman using typical meteorological year data. The LiBr–H₂O cooling offers 40% and 55% more output energy than fogging cooling at Fahud and Marmul, respectively.

All of these works show an increase of power and efficiency of gas turbine by reducing inlet air temperature.

These articles have investigated the effect of inlet air cooling, however, in addition to this, we have studied the amount of thermal energy of exhaust gases and their ability to satisfy the required thermal energy of refrigeration cycle in different conditions of both cycles. For this study we have modeled gas turbine, ejector and absorption refrigeration cycle, and compared the experimental results of simple gas turbine [8] with our results at the same condition to verify the model; see table 1.

Tab. 1. The results of verifying the SGT model

Gas Turbine		GE LM2500	GE MS9331	ABB GT10	WH W501D5
Pressure Ratio		18.9	15	14	14.2
Turbine Inlet Temperature [C]		1258	1353	1218	1180
Turbine Outlet Temperature [C]	experimental	532	610	555	535
	our model	527.6	623.6	561.6	537.5
Efficiency[%]	experimental	34.6	35	33.3	32.8
	our model	36.8	34.5	34.3	34.6
Specific Net Work[kJ/kg]	experimental	315	380	315	295
	our model	340.7	374.2	327.5	315.2

The study shows that, with some pressure ratio (r_c) of gas turbine, because of low COP of ARC, energy of exhaust gases can not provide all needed energy of refrigeration system to have a low and constant inlet temperature. Using ejector in absorption refrigeration system brings about the advantages of absorption and ejector refrigeration systems and provides high COP. So that, the range of r_c with which the thermal energy of exhaust gas of both SGT and RGT is enough for refrigeration cycle, is extended.

A number of models have been suggested to study the effect of utilizing ejector in absorption refrigeration cycle to increase the COP. D. W. Sun Et al [9] combined an ejector cycle and LiBr absorption refrigeration cycle to bring together the advantages of the two conventional cycles. The novel cycle was particularly suitable for being powered by waste thermal energy. S. Wu and I. W. Eames [10] suggested another combination of ejector and absorption refrigeration cycle.

It was complicated than the Sun's cycle, but the effect of using ejector was approximately the same. N. H. Aly et al [11] described a computer simulation model for steam jet ejector. They used a method similar to that used in reference [9]. Alexis and Rogdakis [12] described two simple methods. In the first, an ejector

draws vapour from an evaporator and discharges it to a condenser, in the second, an ejector draws vapour from an evaporator and discharges it to an absorber. The first model gave higher COP than the second one. Sözen and Özalp [13] and Sözen and Yücesu [14] studied an ejector absorption refrigeration cycle in which the ejector was located at the absorber inlet. A. Levy et al [15] studied the performance of an advanced triple-pressure level (TPL) single-stage absorption cycle with refrigerant R125 and various organic absorbents. In the developed TPL cycle, a jet ejector of a special design is used at the absorber inlet. We have used LiBr absorption refrigeration cycle with an ejector at condenser inlet because of , simplicity, 3higher COP and having an environment friendly working fluid. The system was similar to that used by Wen Sun [9].

2. Assumptions

Following typical operating parameters are considered for gas turbine in this work [3], [4]:

1. polytropic efficiency of compressor ($\eta_{\infty,c}$) and turbine ($\eta_{\infty,t}$) are 0.9 and 0.85 respectively.
2. Methane (CH₄) with low heat value of 50010 kJ/kg is used as fuel and its pressure and temperature are the same as that of combustion chamber inlet.

3. Combustion efficiency (η_{cc}) is 0.98 and its pressure drop is 5% of combustion chamber inlet pressure.
4. Pressure drop of both compressor inlet and turbine outlet is 1kPa.
5. Heat exchanger efficiency in RGT (ϵ_{HE}) is 0.85.
6. Mechanical efficiency (η_m) is 0.98.
7. ISO standard conditions for inlet air is $T = 15^\circ\text{C}$, $P = 100\text{kPa}$ and $\phi = 60\%$.
8. Minimum Stack temperature is 100°C .
9. Minimum inlet temperature to prevent icing at the compressor inlet is 12°C .

Following parameters were chose for the studying of ejector absorption refrigeration cycle[9], [10]:

10. Condenser temperature (T_{cond}) = 45°C , absorber temperature (T_{abs}) = 45°C , evaporator temperature (T_{eva}) = 8°C , generator temperature (T_{gen}) = 95°C , heat exchanger efficiency in refrigeration cycle (η_{ex}) = 90%, generator pressure (P_{gen}) = 10KPa, ejector area ratio (A_r) = 10, nozzle efficiency (η_n) and diffuser efficiency (η_d) are 90%.

A parametric study was carried out changing one parameter at a time and keeping the others fixed. For ARC the assumptions are similar to these values, except that $P_{\text{cond}} = P_{\text{gen}} = P_{\text{sat } T_{\text{cond}}}$ ($P_{\text{sat } T_{\text{cond}}}$ is saturated pressure at T_{cond}) and A_r , η_n and η_d are omitted.

3. Studied Cycle and Used Equations for Simulation

Fig. 1 shows RGT with Ejector- Absorption Refrigeration Cycle (EARC). When we study the effect of inlet air cooling in SGT, heat exchanger will be omitted; and when we want to use ARC, we omit the ejector and line 13 of steam. An ejector integrated in this way into the ARC increase the refrigerant flow rate from the evaporator and therefore raises the cooling capacity of the machine. Thermodynamic analysis of each component is given briefly below:

3-1. Compressor

From following equation, for given inlet conditions, r_c , and compressor polytropic efficiency, $T_{2\text{gen}}$ can be estimated:

$$\int_{T_{1\text{gt}}}^{T_{2\text{gt}}} \bar{C}_{p,a} \frac{dT}{T} = \int_{P_{1\text{gt}}}^{P_{2\text{gt}}} \frac{\bar{R}}{\eta_{\infty,c} P} dP \quad (1)$$

Assuming an adiabatic flow, compressor specific work (for 1 kg of inlet air) can be calculated from: (M_a is molecular mass of inlet air)

$$w_c = \frac{\int_{T_{1\text{gt}}}^{T_{2\text{gt}}} \bar{C}_{p,a} dT}{M_a} \quad (2)$$

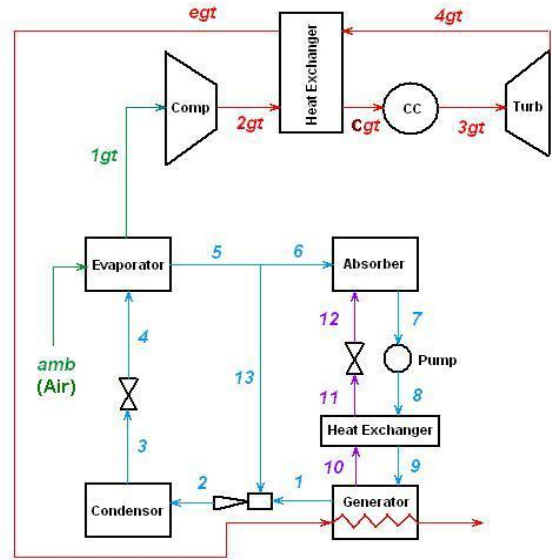
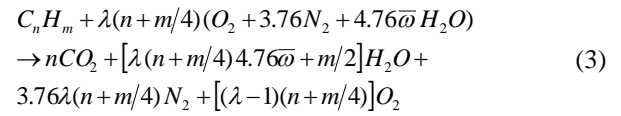

Fig. 1. RGT with EARC

3-2. Combustion Chamber

Combustion reaction for a fuel with chemical formula of C_nH_m with considering humidity of the air can be written as:



We assume that, the combustion process is complete and nitrogen dose not participate in reaction.

Excess Air Coefficient (λ) can be calculated from The first law of thermodynamics for an adiabatic combustion process for any given turbine inlet temperature (TIT); and then the fuel-air ratio (f) can be calculated from Eq.(4) by considering a value for η_{cc} . ($\bar{\omega}$ is Molar humidity ratio)

$$f = \frac{12n + m}{\lambda(n+m/4)4.76(1+\bar{\omega})M_a\eta_{cc}} \quad (4)$$

3-3. Heat Exchanger

In the heat exchanger the exhaust gas from the turbine is used to heat air before it enters the combustion chamber, and therefore the fuel consumption is reduced in the combustion chamber. The energy balance for this process is:

$$\int_{T_{2\text{gt}}}^{T_{c\text{gt}}} \bar{C}_{p,a} dt = (1+f) \int_{T_{e\text{gt}}}^{T_{4\text{gt}}} \bar{C}_{p,g} dt \quad (5)$$

For calculating $T_{c\text{gt}}$ and $T_{e\text{gt}}$ we use heat exchanger effectiveness equation in addition to Eq. (5):

$$\epsilon_{HE} = \frac{\int_{T_{2\text{gt}}}^{T_{c\text{gt}}} \bar{C}_{p,a} dt}{\int_{T_{2\text{gt}}}^{T_{4\text{gt}}} \bar{C}_{p,a} dt} \quad (6)$$

3-4. Turbine

Turbine outlet temperature for a given TIT, r_c , and $\eta_{\infty,t}$ can be estimated from:

$$\int_{T_{4,gt}}^{T_{3,gt}} \bar{C}_{P,g} \frac{dT}{T} = \int_{P_{4,gt}}^{P_{3,gt}} \frac{\bar{R}}{\eta_{\infty,t} P} dP \quad (7)$$

In this equation $\bar{C}_{P,g}$ will be calculated from Eq. (8):

$$\int_{T_4}^{T_3} \bar{C}_{P,g1} \frac{dT}{T} = \int_{P_4}^{P_3} \frac{\bar{R}}{\eta_{\infty,t} P} dP \quad (8)$$

Assuming no heat transfer from the turbine, turbine specific work can also be evaluated from:

$$w_t = (1 + f) \frac{\int_{T_{4,gt}}^{T_{3,gt}} \bar{C}_{P,g} dT}{M_g} \quad (9)$$

Analyzing the performance of modern gas turbine engines without prediction of the cooling air flow, leads to inaccurate results as this flow is a large fraction of the inlet air flow in these machines. As cooling flows are complex functions of turbine operating and design parameters accurate modeling of cooling air flow is a complex task [16-20]. For a general thermodynamic analysis of gas turbine with blade cooling, it is better to use a much simpler computing procedure which requires little input data and gives reasonably accurate results. Therefore for estimation of cooling air we chose the model developed by Sarabchi [21].

3-5. Inlet Air Cooling of Compressor

The first thermodynamic law is used for calculating cooling load of refrigeration cycle: In this equation subscripts da, v and L express dry air, water vapor and liquid water respectively.

$$\begin{aligned} Q_{eva} = & (h_{da,1gt} + \omega_{1gt} h_{v,1gt}) - \\ & (h_{da,amb} + \omega_{amb} h_{v,amb}) + (\omega_{amb} - \omega_{1gt}) h_{L,1gt} \end{aligned} \quad (10)$$

Humidity ratio (ω) for given relative humidity (ϕ) can be estimated from:

$$\omega = \frac{0.622 \phi P_{sat}}{P} \quad (11)$$

3-6. EARC

The operation of the EARC is characterized by the generator, condenser, absorber and evaporator temperatures and the refrigerant entrainment ratio. The concentration of LiBr in weak and strong solutions at the absorber and generator is specified by their

respective pressures and temperatures. Therefore the cycle can be analyzed as it is presented in ref.[9].

4. Effect of Inlet Air Cooling on SGT and RGT Power and Efficiency

Specific work of SGT and RGT as a function of compressor inlet temperature (T_0) with different r_c and turbine inlet temperature (TIT) is shown in Fig. 2 and Fig. 3 respectively.

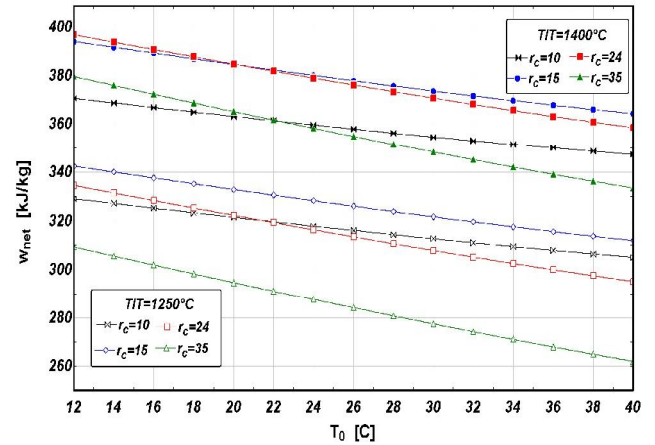

Fig. 2. Effect of compressor inlet air temperature on SGT specific work in different r_c and TIT ($\phi_0=60\%$)

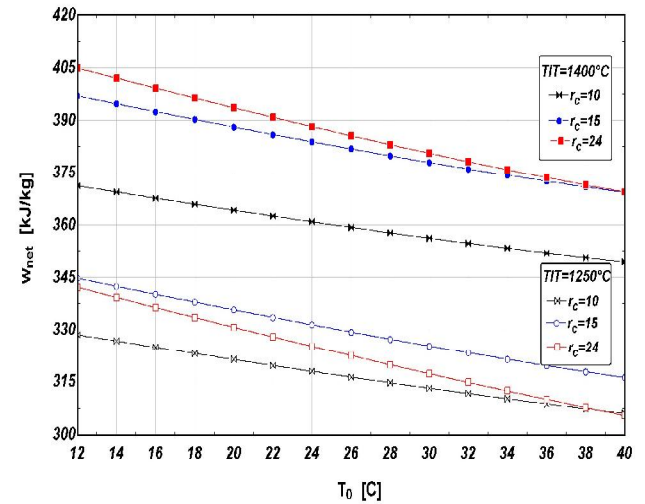

Fig. 3. Effect of compressor inlet air temperature on RGT specific work in different r_c and TIT ($\phi_0=60\%$)

These schemes show that, as T_0 increases, specific work decreases. This variation is linear. The slope of this line increases with a rise in r_c and decreases slightly with rise in TIT. Fig. 2 and Fig. 3 show a comparison of specific work of SGT and RGT. In both figures, specific work increases with r_c to the maximum specific work that occurs in optimum r_c and then decreases. For each TIT the optimum r_c is given in Table. 2 that shows the maximum specific work and optimum r_c increases as TIT rises and this is expected from ideal cycle equations [22].

Tab. 2. The effect of TIT on gas turbine maximum specific work obtained with an optimum amount of r_c ($\phi_0=60\%$, $T_0=15^\circ\text{C}$)

TIT [C]	r_c	Max w_{net} [kJ/kg]
1100	13.08	289.5
1250	17.5	339.2
1400	20.1	394.8

Efficiency of SGT and RGT as a function of T_0 with different r_c and TITs is shown in Fig. 4 and Fig. 5 respectively. From these schemes, it is clear that efficiency of SGT and RGT decreases with an increase in inlet temperature and the amount of decrease increases with an increase of r_c . Efficiency of SGT increases with r_c to the maximum amount that occurs in optimum r_c and then decreases. For each TIT, the optimum r_c is given in Table. 3.

The efficiency of RGT decreases with an increase of r_c , because, when r_c increases, temperature of gases in outlet of turbine decrease and temperature of air in outlet of compressor increases, so, the recovered thermal energy in heat exchanger falls until zero corresponding to the r_c that at this point efficiency of SGT and RGT equals. These pressure ratios are presented in Table. 4 for each TIT. For higher values of r_c the heat exchanger would cool the air leaving the compressor and so reduce the efficiency.

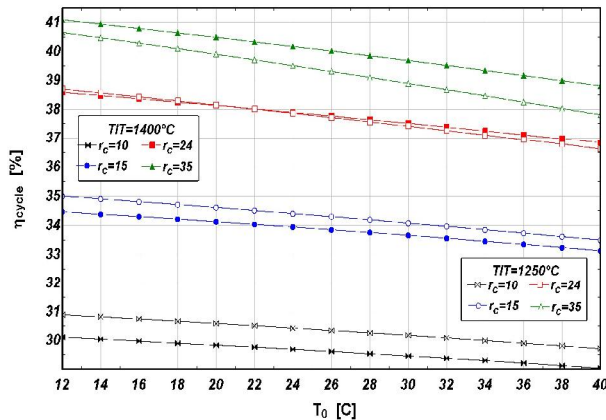

Fig. 4. Effect of compressor inlet air temperature on SGT efficiency in different r_c and TIT ($\phi_0=60\%$)

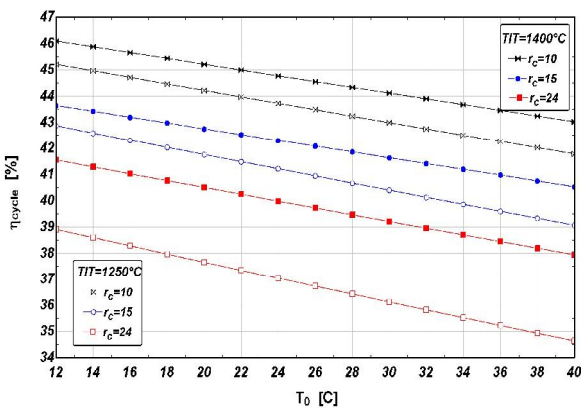

Fig. 5. Effect of compressor inlet air temperature on RGT efficiency in different r_c and TIT ($\phi_0=60\%$)

Tab. 3. Effect of TIT on SGT maximum efficiency and its r_c ($\phi_0=60\%$, $T_0=15^\circ\text{C}$)

TIT [C]	r_c	Max η_{Cycle} [%]
1100	35.98	39.42
1250	47.6	40.94
1400	62.6	42.57

Tab. 4. Maximum r_c for RGT with different TITs.

TIT [C]	1100	1250	1400
r_c	19	24	29

5. Density Change of Inlet Air

It is mentioned that the adverse effect of high inlet air temperature on the power output and efficiency of a gas turbine is twofold:

1. A higher intake air temperature results in an increase of the specific compressor work, and therefore, in a reduction of power output and efficiency
2. Each gas turbine has a constant volumetric flow rate of air; so, as the air temperature increases, the air density and, consequently, its mass flow rate decreases. The reduced air mass flow rate directly causes the gas turbine to produce less output power.

The first case is studied in previous sections. In this section we study the second case. Fig. 6 shows the air density variation with temperature. It shows that, output power will increase by a percentage of about 3.4 for every 10 °C of inlet air temperature decrease.

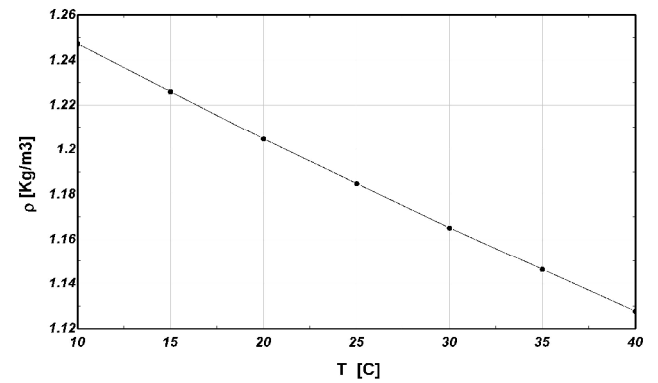

Fig. 6. Effect of temperature on density of air [23]

6. Cooling Capacities Obtainable From the SGT and RGT Exhaust Gases in ARC and EARC

In previous sections, it was shown that a decrease of compressor inlet air temperature causes an increase of efficiency and specific work of gas turbine. In this section we will consider, the required cooling capacity (Q_{eva}) to have a specified temperature and humidity in compressor inlet air, the required thermal energy in generator (Q_{gan}) to achieve the cooling capacity and the thermal energy available in exhaust gases ($Q_{gen,available}$) of SGT and RGT. In Fig. 7, Q_{eva} is shown as a function of ambient temperature (T_{amb}) at the compressor inlet conditions.

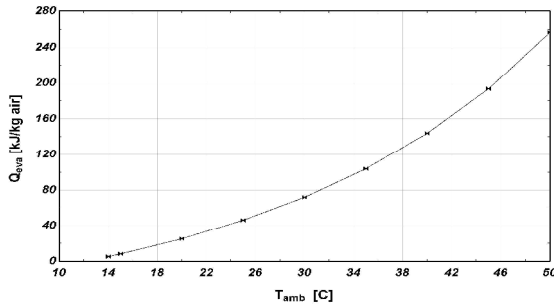

Fig. 7. Required cooling capacity for inlet air cooling as a function of ambient temperature ($T_0=12^\circ\text{C}$, $\phi_{\text{amb}}=60\%$, $\phi_0=60\%$)

It indicates that, an increase of T_{amb} causes an increase of Q_{eva} to achieve compressor inlet condition ($T_0=12^\circ\text{C}$, $\phi_0=60\%$). To achieve the cooling capacity, Q_{gan} of ARC and EARC is calculated as a function of T_{amb} and it is shown in Figs. 8-9 respectively. It is clear that when T_{amb} increases Q_{gan} increases too. Also, Fig. 9 shows increase of Q_{gan} with increase of P_{gan} and with decrease of A_r . Figs. 10-13 show the variation of Q_{gan} with refrigeration system parameters for ARC and Figs. 14-17 show these variations for EARC. In general, Q_{gan} of EARC is lower than that of ARC because of ejector presence that increases COP of refrigeration cycle. In both ARC and EARC, Q_{gan} increases with increase of absorber, condenser, generator temperatures and decrease of evaporator temperature. Also, in EARC, Q_{gan} increases when P_{gan} increases and/or A_r decreases, but we will focus on the same parameters of EARC and ARC (absorber, condenser, generator and evaporator temperatures).

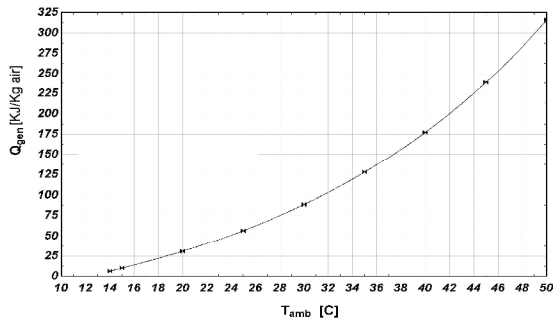

Fig. 8. ARC required energy as a function of ambient temperature for providing specified inlet cooling ($T_0=12^\circ\text{C}$, $\phi_{\text{amb}}=60\%$, $\phi_0=60\%$)

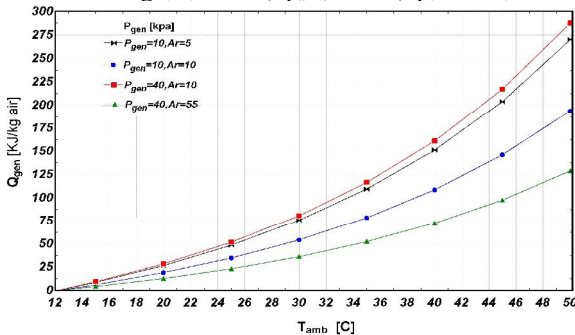

Fig 9: EARC required energy as a function of ambient temperature, P_{gan} and A_r for providing specified inlet cooling ($T_0=12^\circ\text{C}$, $\phi_{\text{amb}}=60\%$, $\phi_0=60\%$)

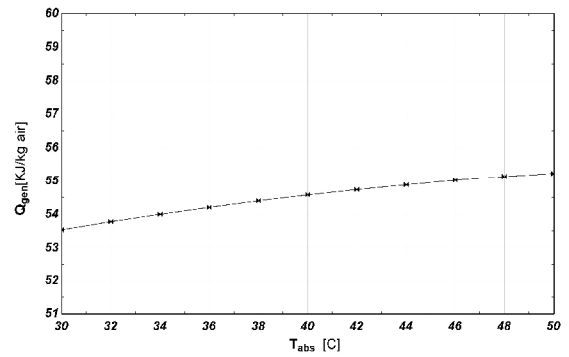

Fig 10: ARC required energy as a function of T_{abs} for providing specified inlet cooling ($T_{\text{amb}}=25^\circ\text{C}$, $T_0=12^\circ\text{C}$, $\phi_{\text{amb}}=60\%$, $\phi_0=60\%$)

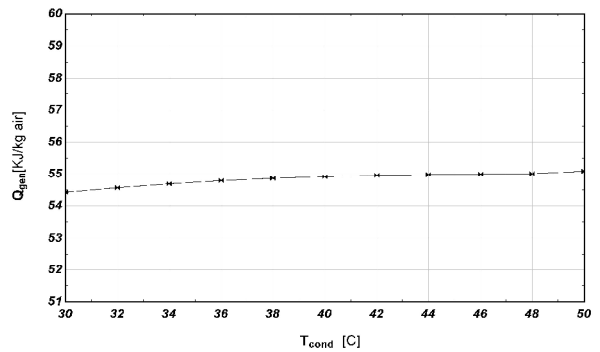

Fig 11: ARC required energy as a function of T_{cond} for providing specified inlet cooling ($T_{\text{amb}}=25^\circ\text{C}$, $T_0=12^\circ\text{C}$, $\phi_{\text{amb}}=60\%$, $\phi_0=60\%$)

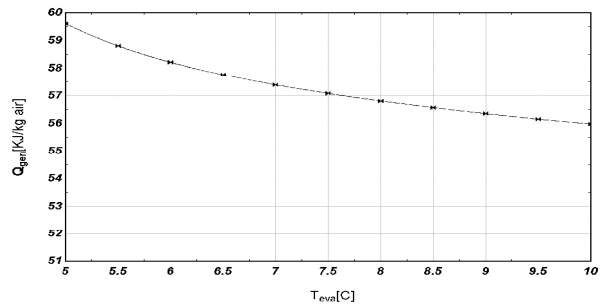

Fig. 12. ARC required energy as a function of T_{eva} for providing specified inlet cooling ($T_{\text{amb}}=25^\circ\text{C}$, $T_0=12^\circ\text{C}$, $\phi_{\text{amb}}=60\%$, $\phi_0=60\%$)

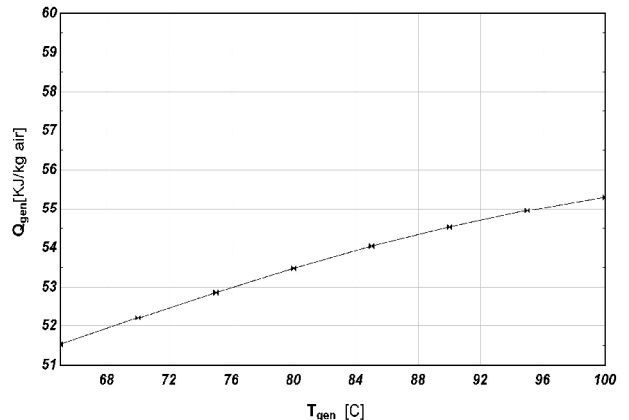

Fig. 13. ARC required energy as a function of T_{gen} for providing specified inlet cooling ($T_{\text{amb}}=25^\circ\text{C}$, $T_0=12^\circ\text{C}$, $\phi_{\text{amb}}=60\%$, $\phi_0=60\%$)

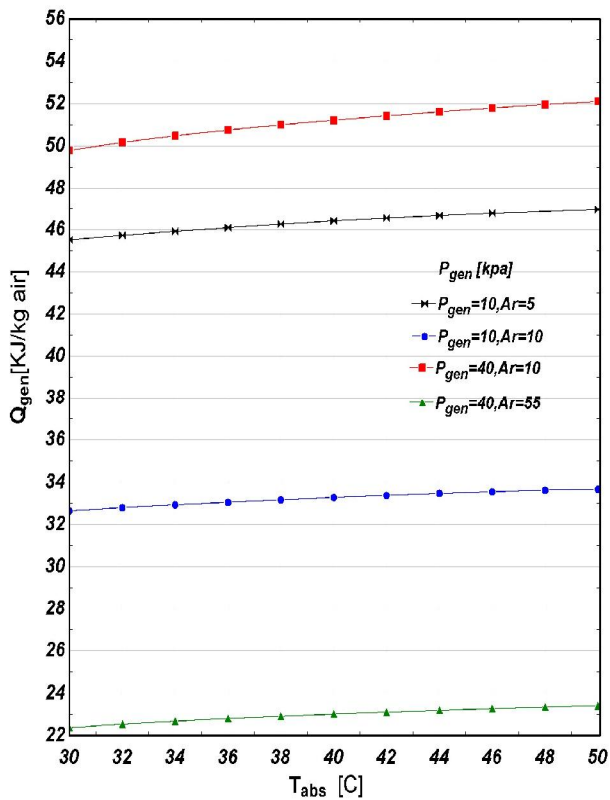

Fig. 14. EARC required energy as a function of T_{abs} , P_{gen} and A_r for providing specified inlet cooling ($T_{amb}=25^{\circ}C$, $T_0=12^{\circ}C$, $\phi_{amb}=60\%$, $\phi_0=60\%$)

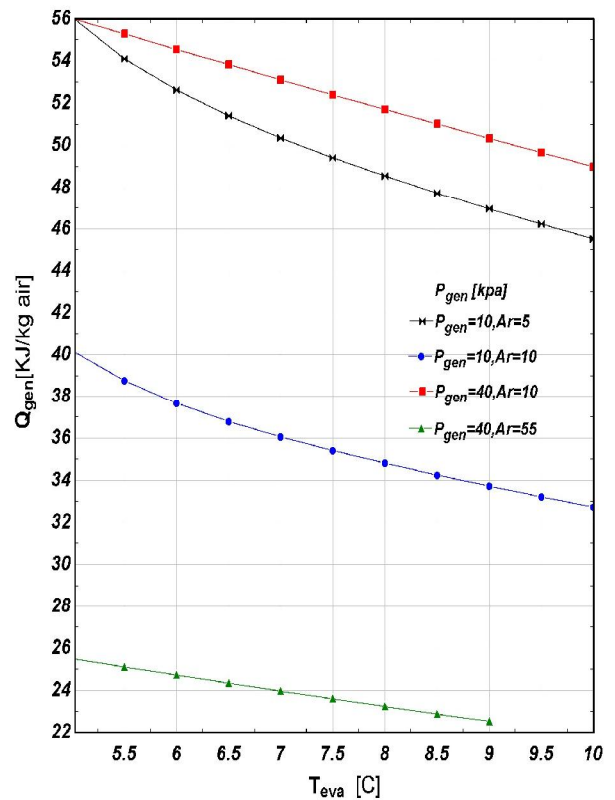

Fig. 16. EARC required energy as a function of T_{eva} , P_{gen} and A_r for providing specified inlet cooling ($T_{amb}=25^{\circ}C$, $T_0=12^{\circ}C$, $\phi_{amb}=60\%$, $\phi_0=60\%$)

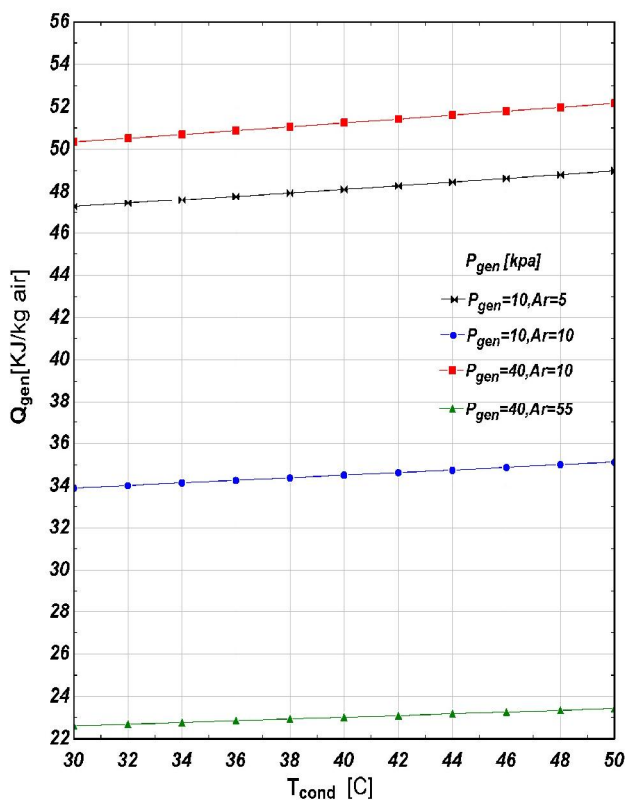

Fig. 15. EARC required energy as a function of T_{cond} , P_{gen} and A_r for providing specified inlet cooling ($T_{amb}=25^{\circ}C$, $T_0=12^{\circ}C$, $\phi_{amb}=60\%$, $\phi_0=60\%$)

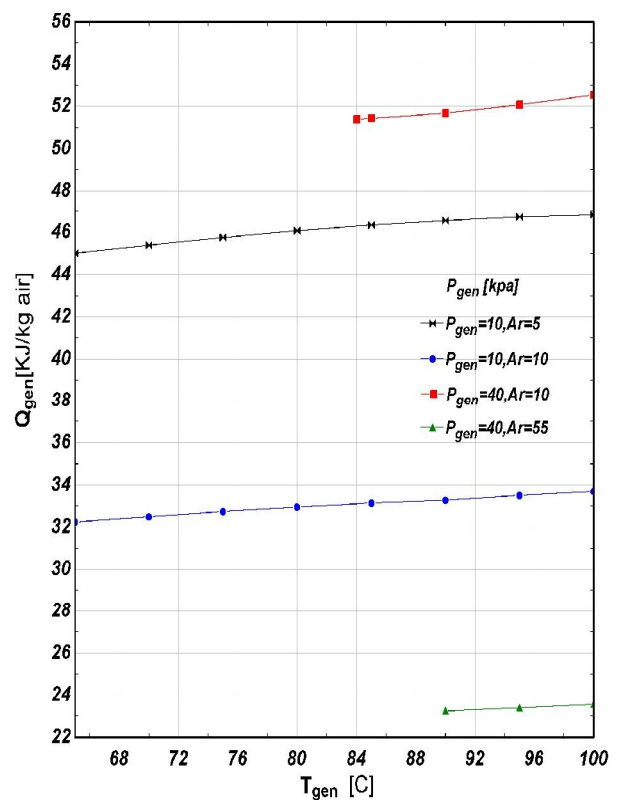

Fig. 17. EARC required energy as a function of T_{gen} , P_{gen} and A_r for providing specified inlet cooling ($T_{amb}=25^{\circ}C$, $T_0=12^{\circ}C$, $\phi_{amb}=60\%$, $\phi_0=60\%$)

In order to study the amount of required energy that can be provided from exhaust gases, available energy in exhaust gases of SGT and RGT is presented in Fig. 18 and Fig. 19 with different TITs.

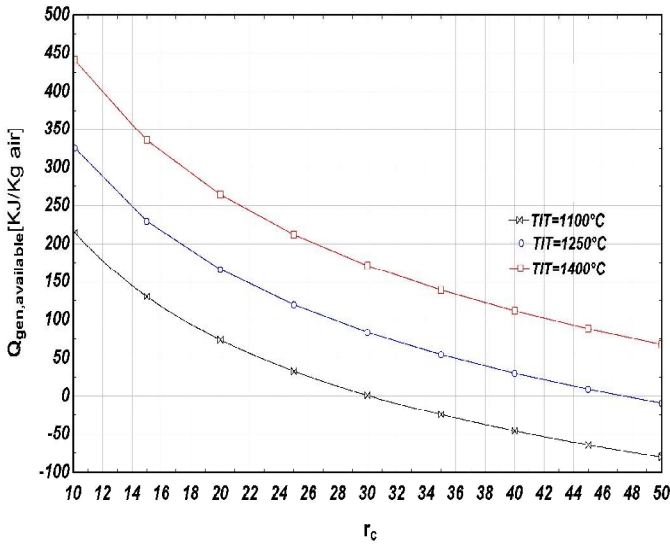

Fig. 18. Thermal energy of SGT exhaust gases as a function of r_c and TIT ($T_0=12^\circ\text{C}$, $\phi_0=60\%$)

The effective factors in the amount of $Q_{\text{gen,available}}$ are r_c and TIT. From the Figures it is clear that, for SGT, $Q_{\text{gen,available}}$ decreases with increase of r_c as the turbine outlet temperature falls. But in RGT the trend is inverse because of decreased recovered thermal energy in heat exchanger. In both SGT and RGT $Q_{\text{gen,available}}$ increases with an increase of TIT.

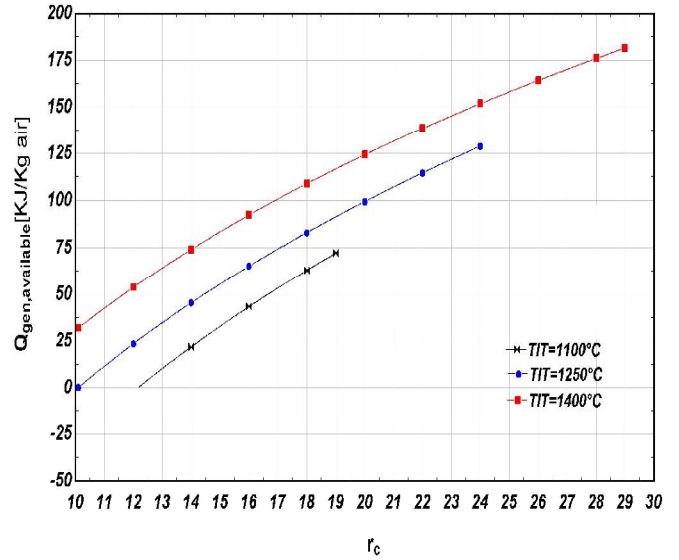

Fig. 19. Thermal energy of RGT exhaust gases as a function of r_c and TIT ($T_0=12^\circ\text{C}$, $\phi_0=60\%$)

Now, we characterize the conditions with which Q_{gan} can be supplied from $Q_{\text{gen,available}}$. The tables 5-7 are obtained from a comparison of Figs. 8-17 with Figs. 18-19. Table 5 shows the Variation of r_c with ambient temperature with which Q_{gan} equals to $Q_{\text{gen,available}}$ for all studied cycles. This table indicates that, for SGT, in all r_c lower than that mentioned in the table, Q_{gan} can be provided from $Q_{\text{gen,available}}$ completely, but for RGT with r_c higher than mentioned in table, up to the value given in Table. 4 for each TIT, Q_{gan} can be supplied from $Q_{\text{gen,available}}$. The same discussion can be made for Tables 6 and 7, which show the effect of TIT and different parameters of refrigeration cycle on the r_c with which Q_{gan} equals to $Q_{\text{gen,available}}$.

Tab. 5. Variation of Q_{gen} and $Q_{\text{gen,available}}$ equivalence r_c with ambient temperature (TIT=1250°C)

$T_{\text{amb}}[\text{C}]$	ARC			EARC		
	$Q_{\text{gen}}=Q_{\text{gen,available}}$ [kJ/kg air]	r_c (SGT)	r_c (RGT)	$Q_{\text{gen}}=Q_{\text{gen,available}}$ [kJ/kg air]	r_c (SGT)	r_c (RGT)
25	56.81	34.52	15.14	34.81	38.9	13
35	128	23.98	23.85	78.42	30.8	17.5
40	177.2	19	31.9	108.6	26.4	21.2

Tab. 6. Variation of Q_{gen} and $Q_{\text{gen,available}}$ equivalence r_c with TIT($T_{\text{amb}}=25^\circ\text{C}$)

TIT[C]	ARC			EARC		
	$Q_{\text{gen}}=Q_{\text{gen,available}}$ [kJ/kg air]	r_c (SGT)	r_c (RGT)	$Q_{\text{gen}}=Q_{\text{gen,available}}$ [kJ/kg air]	r_c (SGT)	r_c (RGT)
1100	56.81	21.9	17.35	34.81	24.7	15.18
1250	56.81	34.52	15.4	34.81	38.9	13
1400	56.81	56.91	12.29	34.81	37.5	10.35

Tab. 7. Variation of Q_{gen} and $Q_{gen,available}$ equivalence r_c with parameters of refrigeration cycle ($T_{amb}=25^\circ\text{C}$, $T_0=12^\circ\text{C}$, $\phi_{amb}=60\%$, $\phi_0=60\%$, $TIT=1250^\circ\text{C}$)

$T_{gen}[C]$	ARC			EARC		
	$Q_{gen}=Q_{gen,available}$ [kJ/kg air]	r_c (SGT)	r_c (RGT)	$Q_{gen}=Q_{gen,available}$ [kJ/kg air]	r_c (SGT)	r_c (RGT)
75	52.86	35.27	14.73	32.74	39.35	12.75
85	54.04	35.04	14.85	33.15	39.3	12.85
95	56.81	34.54	15.14	34.81	38.9	13
$T_{eva}[C]$						
5	59.61	34	15.42	40.2	37.7	13.5
8	56.81	34.52	15.14	34.81	38.9	13
10	55.98	34.7	15.04	32.72	39.35	12.08
$T_{abs}[C]$						
30	54.2	35	14.85	33.07	39.3	12.85
45	56.84	34.52	15.4	34.81	38.9	13
50	63.34	33.35	15.8	46.92	36.4	14.15
$T_{cond}[C]$						
30	54.96	34.85	14.94	33.9	39.1	12.9
45	56.81	34.52	15.4	34.81	38.9	13
50	64.15	33.2	15.9	35.13	38.85	13.05

It is shown that, by using ejector in refrigeration cycle, the range of r_c that, the thermal energy of exhaust gases is enough for refrigeration cycle is extended in both SGT and RGT.

7. Conclusions

In this research firstly the effect of inlet air cooling on performance of gas turbine is studied. In both SGT and RGT cycles a reduction of inlet temperature showed an increase of power and efficiency especially with high r_c . The maximum power and efficiency of SGT and the r_c corresponding to these maximum amounts increased with a decrease of inlet temperature. These values are presented in Tables 8 and 9.

These tables show that, the maximum specific work and efficiency of SGT increases 1.9% and 1.6% respectively with every 5°C decrease of inlet air temperature.

It is clear that, the maximum specific work of RGT behaves like SGT and their amounts are the same approximately. Also, it is shown that for SGT, with low r_c exhaust gases have enough thermal energy to supply required energy of ARC, but in RGT, with low r_c exhaust gases do not carry enough energy to provide all required energy of ARC. In SGT with high r_c exhaust gases do not provide the needed energy for ARC.

Tab. 8. Effect of compressor inlet air temperature on SGT maximum specific work and its r_c ($TIT=1250^\circ\text{C}$)

$T_0[C]$	r_c	Max W_{net} [kJ/kg air]
12	16.4	343
15	16.11	339.2
20	15.65	333
40	14.12	312.2

Tab. 9. Effect of compressor inlet air temperature on SGT maximum efficiency and its r_c ($TIT=1250^\circ\text{C}$)

$T_0[C]$	r_c	Max η_{cycle} [%]
12	49.05	41.32
15	47.6	40.94
20	45.34	40.32
40	38.02	37.86

Utilization of ejector decreases required energy of refrigeration system, so that, the range of r_c with which, the thermal energy of exhaust gases is enough for refrigeration cycle is extended for both SGT and RGT cycles.

Finally, the effect of refrigeration cycle parameters on the range of r_c with which Q_{gan} can be provided from $Q_{gen,available}$ completely is studied. It was shown that, Q_{gan} decreases with a decrease of absorber, condenser, generator temperatures and an increase of evaporator temperature in both ARC and EARC and Q_{gan} decreases with a decrease of P_{gan} . Therefore with these variations the mentioned range of r_c will be extended.

References

- [1] Sigler, J., Erickson, D., Blanco, H.P., *Gas Turbine Inlet Cooling Using Absorption Refrigeration: a Comparison Based on a Combined Cycle Process*, ASME TURBO EXPO, GT-0408, 2001.
- [2] Kakaras, E., Doukelis, A., Scharfe, J., *Application of Gas Turbine Plants with Cooled Compressor Intake Air*, ASME TURBO EXPO, GT-0110, 2001.
- [3] Bassily, A.M., *Performance Improvements of the Intercooled Reheat Recuperated Gas-Turbine Cycle Using Absorption Inlet-Cooling and Evaporative After-Cooling*, Applied Energy, 77, 2004, pp. 249-272.

- [4] Wang, F.J., Chiou, J.S., *Integration of Steam Injection and Inlet air Cooling for a Gas Turbine Generation System*, Energy Conversion and Management, 45, 2004, pp. 15-26.
- [5] Ameri, M., Hejazi, S.H., *The Study of Capacity Enhancement of the Chabahar Gas Turbine Installation Using an Absorption Chiller*, Applied Thermal Engineering, 24, 2004, pp. 59-68.
- [6] Kakaras, E., Doukelis, A., Karellas, S., *Compressor Intake-Air Cooling in Gas Turbine Plants*, Journal of Energy, 29, 2004, pp. 2347-2358.
- [7] Dawoud, B., Zurigat, Y.H., Bortmany, J., *Thermodynamic Assessment of Power Requirement and Impact of Different gas Turbine Inlet Air Cooling Techniques at Two Different Location in Oman*, Applied Thermal Engineering, 25, 2005, pp. 1579-1598.
- [8] Sarabchi, K., *Performance Evaluation of Reheat Gas Turbine Cycle*, Journal Power & Energy 218, 2004.
- [9] Sun, D.W., Eames, I.W., Aphornratana, S., *Evaluation of a Novel Combined Ejector- Absorption Refrigeration Cycle- i: Copmputer Simulation*, Int J Refrigeration., 19 1996, pp. 172-180.
- [10] Wu, S., Eames, I.W., *A Novel Absorption- Recompression Refrigeration Cycle*. Applied Thermal Eng., 18, 1998, pp. 1149-1157.
- [11] Aly, N.H., Karameldin, A., Shamloul, M.M., *Modelling and Simulation of Jet Ejectors*, Journal of Desalination, 123, 1999, pp. 1-8.
- [12] Alexis, G.K., Rogdakis, E.D., *Performance Characteristics of Two Combined Ejector-Absorption Cycle*, Applied Thermal Eng, 22, 2002, pp. 97-106.
- [13] Sözen, A., Özalp, M., *Performance Improvement of Absorption Refrigeration System Using Triple- Pressure- Level*, Applied Thermal Engineering 23, 2003, pp. 1577-1593.
- [14] Sözen, A., Yücesu, H.S., *Performance Improvement of Absorption Heat Transformer*, Renewable Energy, 32, 2007, pp. 267-284.
- [15] Levy, A., Jelinek, M., Borde, I., Ziegler, F., *Performance of an Advanced Absorption Cycle with R125 and Different Absorbents*, Energy, 29, 2004, pp. 2501-2515.
- [16] De Paepe, M., Dick, E., *Cycle Improvement to Steam Injected Gas Turbine*, Journal of Energy Res., 2000, pp. 1081-1107.
- [17] Von Karman Institute For Fluid Dynamics, *Film Cooling And Turbine Blade Heat Transfer*, Lecture series, 1-2, 1982.
- [18] El-Masri, M.A., *On Thermodynamics of Gas-Turbine Cycle: Part 2- a Model for Expansion in Cooled Turbine*, Journal of Engineering for Gas Turbine and Power, 108, 1986, pp. 151-159.
- [19] Erbes, M.R., Gay, R.R., Cohn, A., *A Simulation Code for Analysis of Gas Turbine Power Plants*, ASME paper 89-GT-39, 1989.
- [20] Stecco, S.S., Facchini, B., *A Computer Model for Cooled Expansion in Gas Turbine*. In proceedings of 3rd ASME Cogen Turbo Conference, France, 1989.
- [21] Sarabchi, K., *A Simple Approach to Gas Turbines Modeling*. In proceeding of Al Azhar Engineering 6th International Conference, Cairo, Egypt, 2000.
- [22] Cohen, H., Rogers, G., Saravanamuto, H., *Gas Turbine Theory*, 3rd ed., Longman, Scientific and Technical, Singapore, 1987.
- [23] Kays, W.M., Crawford, M., *Convective Heat and Mass Transfer*, 3rd ed., Mc Graw-Hill, 1995.