



Calculation and Analysis of Reliability with Consideration of Common Cause Failures (CCF) (Case Study: The Input of the Dynamic Positioning System of a Submarine)

Ali Eghbali Babadi, Mahdi Karbasian* & Fatemeh Hasani

Ali Eghbali Babadi, Department of industrial engineering, Malek-Ashtar University of Technology

Mahdi Karbasian, Department of industrial engineering, Malek-Ashtar University of Technology

Fatemeh Hasani, Department of industrial engineering, Islamic Azad University

KEYWORDS

Reliability,
Dependent Failure,
Common Cause Failure,
Reliability Block Diagram,
Dynamic Positioning System.

ABSTRACT

The reliability and safety of any system is the most important qualitative characteristic of a system. This qualitative characteristic is of particular importance in systems whose functions are under various stresses such as high temperature, high speed, high pressure, etc. A considerable point, which is rarely taken into account when calculating the reliability and safety of systems, is the presence of dependency among subsystems, and this dependency causes various failures in a system, one of the most important of which is the common cause failure (CCF). Failing to consider common cause failures in the calculation of system reliabilities leads to optimistic estimations of system reliability rates, which results in too much trust in the system. In this paper, first, we deal with identifying the reliability of the input of a dynamic positioning system consisting of different environmental sensors and various positioning systems with the aid of PBS and FFBD techniques. Then, we will calculate and allocate the above-mentioned reliability with the aid of a RBD. The common cause failures of different subsystems are considered in calculating the reliability of the previously mentioned system with the aid of IEC 61508 standard, and then the degree of effectiveness of common cause failures in reliability of the studied system is obtained. Finally, by considering different assumptions for the system under study, it is proved that the less the amount of the reliability of dependent components is, the higher the effectiveness of common cause failures in the system reliability will be.

© 2017 IUST Publication, IJIEPR. Vol. 28, No. 2, All Rights Reserved

1. Introduction

With the advent of new technologies and manufacturing processes [1] in various sensitive

areas, production of various components and equipment, and intense competition among various companies, the importance of the proper function of these components and equipment is perceived more than ever before. In addition, a crucial issue in systems performing under stressful environmental conditions is to guarantee the satisfactory reliability of their performance

* Corresponding author: Mahdi Karbasian

Email: mkarbasi@mut-es.ac.ir

Received 17 March 2017; revised 7 June 2017; accepted 15 July 2017

[2]. Engineer's main concern about the systems is, largely, the proper functioning of equipment at the designated time. One of the primary tasks of any product is to meet the consumers' demands and needs, as well as to satisfy a reasonable level of reliability [3,4]. Modern engineering products, including single components to large systems, must be designed and manufactured in a way as to possess the required reliability during their mission. In any industry, when a system stops working or experiences disorders, it becomes risky and harmful in various terms, such as in economic, human, political terms, etc [5]. Reliability is one of the most important qualitative characteristics of components, products, and large and complex systems, especially satellite-carrier and space structures, nuclear systems, ships, and submarines [6]. What is certain is that reliability is different in various products. For instance, a nuclear submarine, which travels long distances under the ocean, and a spaceship, which passes through the atmosphere, cause different perceptions about the concept of reliability [7].

Reliability is a general concept, known as a positive characteristic for an individual or a product for many years. The beginning of its use was in 1816, much older than what many people expect it to be. A poet named Samuel Taylor Coleridge [8] invented the word "reliability" for the first time. Shortly after 1912, after the Titanic ship disaster, researchers in the field of designing systems with parallel and/or spare channels [9] conducted a research to prevent similar accidents. The nature of this study was to increase system's reliability with the aid of designing systems with parallel components. In the 1920s, improvement in products was achieved using the statistical quality control developed by Dr. Walter Shewhart at Bell Labs [10]. However, these cases have just been a small part of efforts made by researchers and engineers to enhance reliability. It should be taken into consideration that until World War II, reliability had been defined as a word, meaning the quality of being able to be trusted or as repeatability. With reliability being refined and redefined by the United States Army in the 1940s, the new definition has been used ever since. As mentioned, many things had been done in the past to enhance lifetime and reliability of products, but the beginning of using the concept of reliability, in its current form, was in the 1940s [11].

In the 1940s, as World War II began and complex military tools were produced, Le Sueur and

Murphy carried out the modelling of reliability. During this period, many of the tasks related to reliability were done by conducting tests on materials and their fatigue. Miner published the first articles in the field of reliability under the title of "Cumulative damage in fatigue" in ASME Journal in 1945 [11]. Maybe it can be said that the serious emergence and birth of reliability engineering was in the 1950s due to many activities, such as efforts to improve the reliability of devices through data collection and design, formation of the first symposium on quality and reliability engineering, formation of Agree and IEEE study groups, publication of first books in this field by Baszucki, development of statistical techniques, and presentation of U.S. military handbooks as instructions for the application of reliability in electronic components [12], done during this period to consolidate reliability engineering. Nevertheless, the growth of the concept of reliability continued, and several activities were done in this regard in the next decades. Considering the birth and growth of reliability in the 1950s, 1960s, and 1970s, this discipline has grown significantly after spending these three decades. As mentioned, in the decades before the 1950s, events, such as the Titanic ship disaster and so on, had attracted engineers and scientists' attention. However, due to the absence of the concept of reliability engineering in its current form, most engineers and scientists began to think of solutions such as enhancing the quality of components or developing parallel systems, without any precise calculation and without full knowledge about the system reliability in its current conditions. But, in the late 1970s and 1980s, we witnessed multiple incidents in various industries; namely, New York blackout in 1977, the Three Mile Island nuclear accident (the United States' worst nuclear accident, and the first nuclear reactor disaster) that occurred in Three Mile Island in the United States on March 28, 1979, the Chernobyl nuclear accident (the worst civilian nuclear accident in the world history), which occurred in Reactor No. 4 at the Chernobyl plant in Ukraine in April 26, 1986. In addition, some incidents occurred in the chemical industry, such as the Flixborough disaster in 1974 and The Seveso accident in 1976 in North of Milan in the Lombardy region. The Bhopal accident occurred in Bhopal, India in 1984, as a result of which a toxic gas was leaked from the pesticide plant of the United Carbide American Company, and this disaster resulted in several thousands of deaths and more than 300

thousand injuries. In addition, in aerospace industry, the space shuttle Challenger explosion occurred in 1986. The space shuttle Challenger was exploded into several pieces 73 seconds after its flight, leading to the deaths of all of its seven-crew members. Moreover, all of these events have imposed increasing pressure on various industries to be required to pay attention to the assessment of reliability, safety, and risk probability [9, 13]. This study will deal with measuring input reliability of a dynamic position stabilization system regarding failure effect of common cause, which has been done for the first time in the country. Moreover, it will deal with analysis of the effect of common cause failures on the ability of system reliability by the help of sensitivity analysis. In this study, standard method IEC 61508 was used to consider the effect of common cause failures regarding type of system whose standard will be dealt with in detail.

2. Dependent Failures

In some cases, we witness that a system fails more often than its reliability, which has been predicted based on the independence of members; in rare cases, the probability of the failure of a system is much lower than the prediction done. The mentioned incidents are not because the probability theory is wrong, but because the analyst does not have correct and complete understanding of some dominant causes of failures in the system; therefore, in most of these cases, the predictions are optimistic [12]. In the most cases, studies investigate the reliability based on censored data from machines performance for a manufacturing system [14]

The presence of dependency in a system is one of the problems facing reliability. Dependency increases the probability of failure, and this type of dependency is called positive dependency. The most important problem in failures due to dependency is the problem of identifying these dependencies because there are different dependencies in different systems. From the past till today, many researchers have conducted research on dependencies in various systems, offering multiple classifications of dependencies in systems. The most famous of which is Humphreys and Johnston's classification published by Humphreys and Johnston in an official document in the UK Atomic Energy Authority in 1987, which defined the types of failures occurring in a system due to dependency, as dependent failures include common cause

failures, common mode failures, and cascading failures. This classification is very famous and has been used repeatedly in various studies. For instance, Giuseppe Maori used this classification in his doctoral thesis at the University of York in 2000; Wenjing Sun used it in her master's thesis at the Norwegian University of Science and Technology in 2013. It has also been used in many articles; for example, articles by Yuan-Jian Yang et al. in 2014 and that by Borsk and Holub in 2008 [15, 16, 17, 18, 19]. This classification is presented in Figure 1.

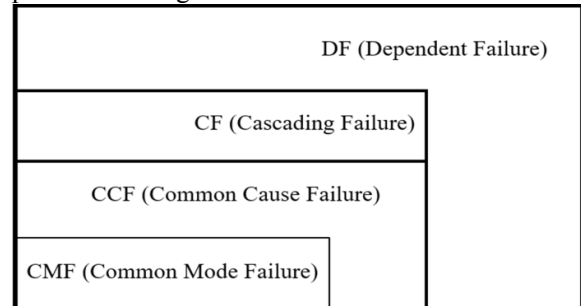

Fig. 1 . Classification of the types of dependent failures [15]

Hence, according to Humphreys and Johnston's classification, the two failures, i.e., common cause failures and cascading failures, are the most important and influential dependent failures, taking into account that cascade failures mostly affect electric power distribution systems and are the main concern of these systems.

3. Common Cause Failures

According to what was mentioned, in sensitive and important systems such as nuclear power plants, aerospace industry, submarines, etc., to obtain a desired reliability level, we should study the potential fault and reasons of destruction (fault) in system [20]. That needs precise calculations and analyses of the system reliability, considering that the system dependency is an important and necessary issue. Common cause failures and their modelling in reliability calculations and analyses for the first time were considered by the United States Nuclear Regulatory Commission in a study on the safety of nuclear reactors in October 1975 [21]. But, the Three Mile Island accident, the world's first nuclear reactor disaster, which occurred in 1979 due to common cause failures, drew many researchers' attention to common cause failures and more accurate calculation of reliability by taking this factor into account. Various studies, such as studies by Edwards and Watson in 1979, Smith Watson in 1980, Johnston

in 1987, Watson and Johnston in 1989, Mosleh in 1991, and Paula et al. in 1991, were carried out and reports of those studies on the safety of nuclear reactors were released in 1998 and 2007 [22].

There are multiple definitions for common cause failures. In a study conducted in 1980, Smith and Watson examined nine different definitions of common cause failures, and concluded that none of these definitions is correct for all engineering fields. Hence, they stated their definition as follows [23]:

Inability of multiple, first-in-line items to perform as required in a defined critical time period due to a single underlying defect or physical phenomena, such that the end effect is judged to be a loss of one or more systems.

Another definition presented by Rausand and Høyland in 2004 defines common cause failures as follows [12]:

A dependent failure in which two or more component fault states exist simultaneously or within a short time interval and are a direct result of a shared cause.

As of 1975, many studies have been conducted on common cause failures, and various models have been offered for it such as the square-root Method, beta-factor model, multivariate exponential distribution models [24], alpha-factor model, binomial failure rate model, and the IEC 61508 standard. Each of these models has its

strengths and weaknesses. In addition, in this paper, we used the IEC 61508 standard to consider common cause failures in the calculation of the reliability of the input of the dynamic positioning system of the submarine being studied. The reason for our use of this standard is that it has regular, accurate, and inclusive checklists in various fields to quantify the effect of system dependency on the development of common cause failures. Of course, the weakness of this standard is that this standard is only for sensors and electronic components.

2-1-1. The IEC 61508 standard

The International Electro-technical Commission (IEC) is an international organization that publishes international standards for all technologies related to electrical systems. This organization was founded in 1906 and has so far published many standards in the field of electrical technology. The organization's subcommittee 65A offered standard No. 61508-6 for electrical safety-related systems. This standard has several annexes. Annex D offers a method to quantify the effect of hardware-related common cause failures [25].

This standard is a very useful and important standard for system reliabilities to the extent that it serves as an umbrella for other standards, and other standards are different branches of this one for their respective industries. These standards are presented in Figure 2 [17].

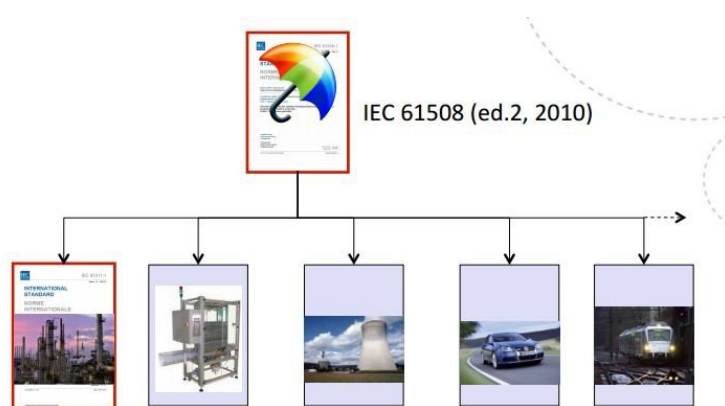

Fig. 2. The IEC 61508 umbrella standard (Wenjing, 2013).

This standard, with an emphasis on the beta factor method, looks for some measures taken to cope with common cause failures so that the probability of common cause failures in systems can be reduced at the time of design. However, a checklist has been prepared based on these measures so that, by taking into account the relationships between the system components, we

can calculate the dependency or probability of common cause failures. It is noteworthy that in the beta-factor model, we knew this number, i.e., β .

These 37 measures are taken in 8 fields that include:

- Separation and segregation of components;

- Diversity and redundancy of components;
- Complexity / Design / Application /Maturity/ Experience;
- Data assessment / analysis and feedback;
- Performance / Human relations;
- Qualification / Training / Safety culture;
- Environmental control;
- Environmental tests.

This checklist is for two types of system components, namely, logical subsystems and sensors and final elements. In addition, as mentioned before, some checklists have been presented in other standards for other components. For instance, in the IEC 62061 standard, a checklist has been presented for electronic components in mechanical systems and industrial machinery.

Using the beta-factor model, common cause failure rates in a system are obtained by relation 1:

$$\lambda_D \cdot \beta \tag{1}$$

Moreover, according to this standard, dependent failure rates, as shown in relation 2, are half of the total failure rate of a system:

$$\lambda_D = 0.5 \lambda \tag{2}$$

Dependent failure rates can be divided into two groups: failures that are outside the coverage of diagnostic tests (therefore cannot be detected); failures that fall within the coverage of diagnostic tests (therefore can finally be detected by diagnostic tests). λ_{DU} is considered as undetectable failure rates of a channel and λ_{DD} as detectable failure rates of a channel. Thus, the

common cause failure rate is equal to relation 3 below:

$$\lambda_D = \lambda_{DU} + \lambda_{DD} \tag{3}$$

According to this standard, undetectable and detectable failure rates are equal to relation 4 and relation 5, respectively, as follows:

$$\lambda_{DU} = \lambda_D (1 - DC) \tag{4}$$

$$\lambda_{DD} = \lambda_D \cdot DC \tag{5}$$

where DC is the coverage of diagnostic tests, determining that the diagnostic tests of the system cover what percentage of the system.

Hence, the probability of each failure is equal to relation 6:

$$Q_{ccf} = \lambda_{DU} \cdot \beta_{int} + \lambda_{DD} \cdot \beta_{int D} \tag{6}$$

In addition, the beta value of calculating the reliability of no-dependency section is required to be in the form of $(1 - \beta)$, which is obtained from relation 7.

$$\beta = 2 \cdot \beta_{int D} \tag{7}$$

The calculation of β_{int} and $\beta_{int D}$ is done according to a checklist presented in Annex D in standard IEC 61508-6, such that having industry specialists fill out the checklist, number S will be obtained according to relation 8 from the addition of values in columns X and Y. However, for $\beta_{int D}$, the only difference is in the value of S, which is obtained from relation 9.

$$S = X + Y \tag{8}$$

$$S_D = X(Z + 1) + Y \tag{9}$$

where Z value of calculating S in $\beta_{int D}$, according to the time intervals for performing diagnostic tests, is presented in Table 1 for programmable electronic equipment and in Table 2 for sensors and/or final elements.

Tab. 1. The value of Z for programmable electronic equipment

Diagnostic coverage	The time interval between diagnostic tests		
	More than 5 minutes	Between 1 and 5 minutes	Less than 5 minutes
≥ 99%	2.0	1.0	0
≥ 90%	1.5	0.5	0
≥ 66%	1.0	0	0

Tab. 2. The value of Z for sensors or final elements

Diagnostic coverage	The time interval between diagnostic tests			
	Less than 2 hours	Between 2 hours and 2 days	Between 2 days and 2 weeks	More than 1 week
≥ 99%	2.0	1.5	1.0	0
≥ 90%	1.5	1.0	0.5	0
≥ 66%	1.0	0.5	0	0

According to the obtained number, the values of β_{int} and $\beta_{int D}$ are shown in Table3.

Tab. 3. Calculation of β_{int} or $\beta_{int D}$

The result ; S or S _D	The time interval of diagnostic tests	
	Logic subsystem	Sensors or final elements
120 or greater	0.5%	1%
Between 70 and 120	1%	2%
Between 45 and 70	2%	5%
Less than 45	5%	10%

However, in the cases where our system is a K-out-of-N system, the value of β_{int} is different. In such cases, IEC 61508 standard considers some coefficients for the obtained β . These coefficients are presented in Table 4 according to different systems.

Tab. 4. Calculation of β for K-out-of-N systems

K components out of N components	N			
	2	3	4	5
1	β_{int}	$0.5 \beta_{int}$	$0.3 \beta_{int}$	$0.2 \beta_{int}$
2	-	$1.5 \beta_{int}$	$0.6 \beta_{int}$	$0.4 \beta_{int}$
3	-	-	$1.75 \beta_{int}$	$0.8 \beta_{int}$
4	-	-	-	$2 \beta_{int}$

3. Dynamic positioning system

Dynamic positioning (DP) is a computer-controlled system to maintain automatically a vessel's position and heading with the aid of receiving information from environmental sensors and positioning systems and by means of thrust force generated by its propellers [26]. A dynamic positioning system includes a mathematical model of a ship, including information related to the direction of forces applied to the vessel as well as the dynamic characteristics of the vessel, and a mathematical model of driving means, including the rudder, driving means, controllable propellers, as well as the location of driving means. The information gathered by environmental sensors and positioning systems makes it possible for the control section to calculate and apply the output required for the proper angle of motion and the thrust force needed for each engine [27, 28]. A dynamic positioning system, like many systems, has input, processing, and output units. Pressure sensors, flow sensors, gyroscopes, compasses, and local and global positioning systems, as reference systems, are responsible for providing information regarding the position of the vessel as well as the magnitude and direction of environmental factors affecting the position of the vessel (the wind force, the force of the sea waves, etc.) to the computer-controlled system. Then, the computerized control system analyzes this information and issues commands to a propulsion system made up of thrusters, propellers, and rudders. These functions are presented in Figure 3.

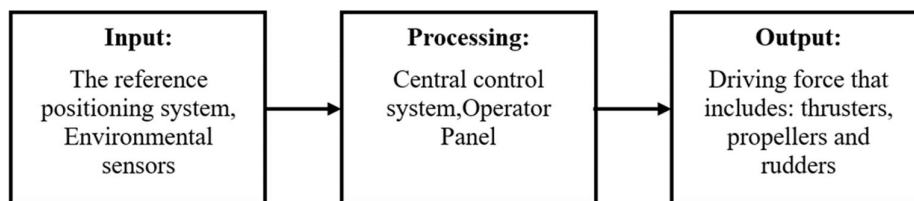

Fig. 3. The 3 sections of a dynamic positioning system

4. System Identification

In this research, we studied the input of the dynamic positioning system of a submarine. In the first stage of this research, we first deal with identifying the system and its subsystems. Then, we draw a functional flow block diagram to analyze the function of the system input and the order in which the components function. Then, we analyze the function of these subsystems and the sequence of their functions so that, with the aid of these analyses, we can identify the existing

dependencies and the type of failures based on which these dependencies occur among the subsystems. With the aid of the product breakdown structure diagram, we found that there are dependencies among the three subsystems: pressure sensors, flow sensors, and Gyroscopes. Then, by analyzing the system and function of these subsystems, we found that there is a dependent failure of the type of common cause failures in these subsystems. Moreover, due to the nature of these subsystems, in which the lack of function of no parallel component causes any

pressure on other components, there is not any dependent failure of the type of cascading failures in this system. Continuing, we present the output of the analyses conducted on the product breakdown structure and functional flow block diagrams.

As mentioned, in this research, we identified and analyzed the subsystems of the system with the aid of the product breakdown structure diagram. The product breakdown structure diagram of the system being studied is presented in Figure 4.

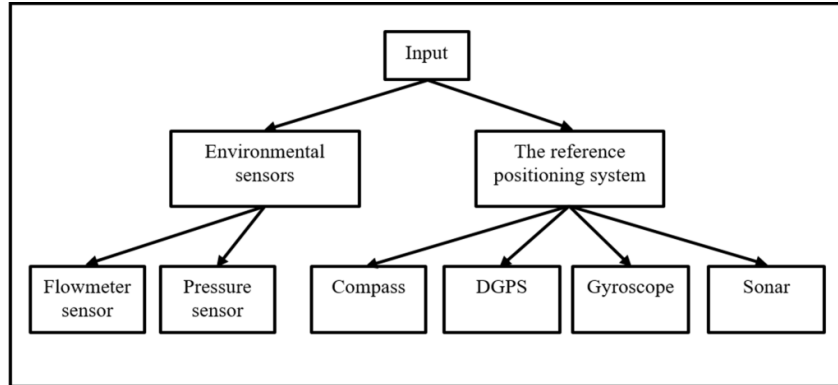

Fig. 4. The product breakdown structure diagram of the input of the system being studied

The input of the system being studied is presented in Figure 5: the functional flow block diagram based on the system levels.

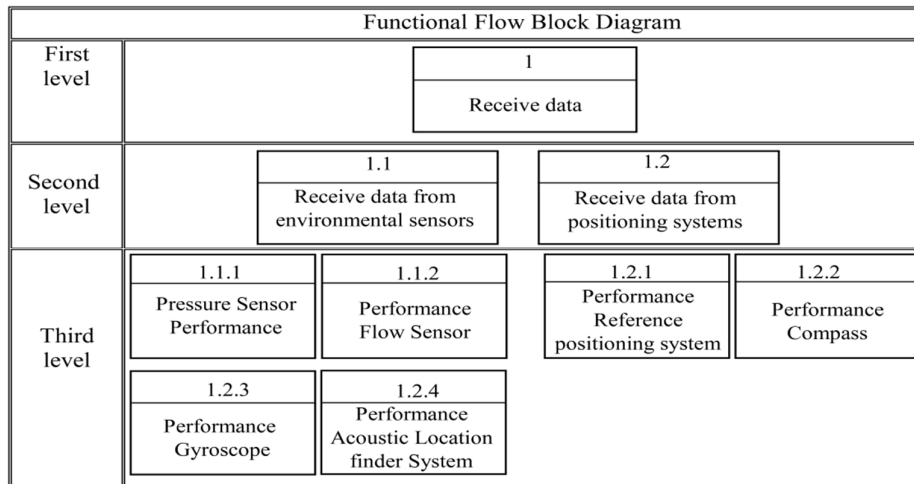

Fig . 5. The functional flow block diagram based on the system levels

Based on the analyses of the product breakdown structure and functional flow block diagrams, we dealt with identifying the components, relation, and function of the input of the dynamic positioning system. The input of the dynamic positioning system of the submarine under study has two subsets: environmental sensors and positioning systems. Environmental sensors include flow sensors and pressure sensors, which are responsible for measuring and determining the direction of the force exerted by the environment on the vessel, such as wind force, sea waves, currents under the sea, and so on. Nexus positioning systems include global

positioning system (GPS), sound navigation and ranging (sonar), gyroscope, and compass, which are responsible for determining the existing coordinates relative to the surrounding environment and the entire Earth. According to the information received from these subsystems, the dynamic positioning system under study controls the ship's motions with the aid of the driving forces.

5. Calculation of Reliability By Considering Common Cause Failures

Given that the system has been identified, we deal with calculating system's reliability by considering common cause failures with the aid

of the reliability block diagram and the IEC 61508 standard in this section. We found from analyzing the product breakdown structure that the system being studied has global positioning system, sound navigation and ranging, gyroscope, and compass in the positioning section and has pressure and flow sensors in the system's environmental analysis section. It should be

noted that through the identification and analysis of the system, we also found that no depth sensor has been employed in the said system, and the depth is calculated using the information received from the pressure sensor and its analysis. Hence, the reliability block diagram of the system being studied is presented in Figure 6.

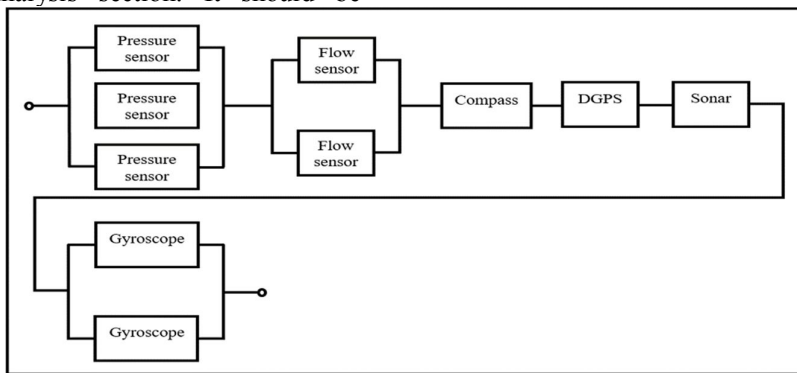

Fig .6. The reliability block diagram of the system under study

This diagram is a geometrical method to show how capabilities of each component lead to success or failure of a system. The values of reliability and other information related to the

input subsystems of the dynamic positioning system of the submarine under study are presented in Table 5.

Tab. 5. The information relating to the system under study

Name subsystems	Failure rate (λ)	Time	Assessment reference	Reliability (R)
Pressure sensor	0.0000252258	400	Catalog	98.996%
Flow Sensor	0.0002644013	400	Catalog	89.964%
Compass	0.00001263135	400	Catalog	99.496%
DGPS	0.00001283135	400	Catalog	99.488%
Gyroscope	0.00005150	400	Catalog	97.961%
Sonar	0.0000254258	400	Catalog	98.988%

In addition, IEC 61508 standard was used to calculate the reliability of the input of the dynamic positioning system of the submarine being studied, by considering the system dependencies. In the input section of the dynamic positioning system, there are dependencies in three subsystems. These three subsystems are flow and pressure sensors and gyroscopes. The dependencies existing in all these three subsystems are of common cause failures type, and as mentioned before, IEC 61508 standard has been used for considering this type of dependency in these three subsystems. The beta value was calculated according to the checklist of this standard, filled by industry specialists and presented in the appendix of this study.

According to this checklist, for pressure sensors, flow sensors, and gyroscopes, the values of $X=$

25, $Y = 17.5$, and $Z = 1.5$; thus, the beta value is obtained as follows:

$$S = X + Y = 25 + 17.5 = 39.5$$

$$S_D = X(Z + 1) + Y = 25(1.5 + 1) + 17.5 = 80$$

According to the values obtained for S and S_D , and as shown in Table 3, the values of β_{int} and $\beta_{int D}$ are equal to:

$$\beta_{int} = 0.1$$

$$\beta_{int D} = 0.02$$

It should be noted that the reason the beta values of these three subsystems are the same is the systematic view of the time of design.

To demonstrate the way of calculating the reliability by considering common cause failures according to IEC 61508 standard, we have detailed the way of calculating the reliability of the set of pressure sensors. According to IEC 61508 standard, the equivalent of the three

parallel pressure sensors is divided into two sections, as shown in Figure 7.

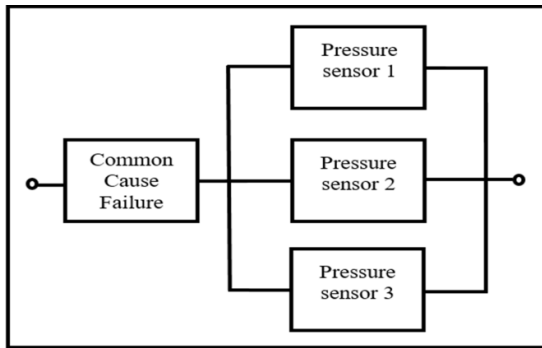

Fig .7. Equivalent of the three pressure sensors

In the first section, given that the coverage of diagnostic tests is equal to 70% in these three systems and since $\lambda_D = 0.5\lambda$ in this standard, λ_{DD} and λ_{DU} are equal to:

$$\lambda = 0.0000252258$$

$$\lambda_D = 0.5 \lambda = 0.0000126126$$

$$\lambda_{DU} = \lambda_D (1 - DC) = \lambda_D \times 0.3 = 0.0000037838$$

$$\lambda_{DD} = \lambda_D \times DC = \lambda_D \times 0.7 = 0.000008829$$

Thus, according to IEC 61508 standard, the failure rate of the common cause failure section is equal to:

$$\begin{aligned} \lambda_c &= \lambda_{DD} \cdot \beta_{int D} + \lambda_{DU} \cdot \beta_{int} \\ &= (0.000008829 \times 0.02) \\ &\quad + (0.0000037838 \times 0.1) \\ &= 0.000000554967 \end{aligned}$$

Considering the calculation time of the system reliability, considered 400 hours, the reliability of the common cause failure section is equal to:

$$R_c = e^{-\lambda t} = e^{-0.00022198704} = 99.9778\%$$

In the second section, according to IEC 61508 standard, where $\beta = 2 \cdot \beta_{int D}$, the independent failure rates of all the three parallel components are equal to:

$$\beta = 2 \cdot \beta_{int D} = 2 \times 0.02 = 0.04$$

$$\begin{aligned} \lambda_i &= (1 - \beta) \lambda = 0.96 \times 0.0000252258 \\ &= 0.000024216768 \end{aligned}$$

Thus, the reliability of the independent section of each pressure sensor is equal to:

$$R = e^{-\lambda t} = e^{-0.0096867072} = 99.036\%$$

Moreover, according to the calculation of the reliability of the parallel components, reliability

of the three pressure sensors in the independent failure section is equal to:

$$\begin{aligned} R_i &= [1 - ((1 - R_1)(1 - R_2)(1 - R_3))] \\ &= 99.999910415\% \end{aligned}$$

According to the calculation of the reliability of series systems, the overall reliability of the three pressure sensors by considering common cause failures is equal to:

$$\begin{aligned} R_T &= R_c \cdot R_i = 99.9778\% \times 99.999910415\% \\ &= 99.97771\% \end{aligned}$$

Nevertheless, if we calculate the overall reliability of the three pressure sensors without considering common cause failures, we will notice that there is a difference between this value and that of system reliability when considering this dependency. This difference is of particular importance in sensitive systems. The value is calculated as follows:

$$\begin{aligned} R &= [1 - (1 - 0.99)(1 - 0.99)(1 - 0.99)] \\ &= 99.999898795\% \end{aligned}$$

Considering the calculations of IEC 61508 standard to measure the common cause failures for the set of pressure sensors, the same method is also used to calculate the reliability by considering common cause failures for the set of flow sensors and the set of gyroscopes. Hence, the reliability of these two sets by considering the probability of common cause failures is equal to:

$$\text{The reliability of the set of flow sensors} = 99.044856\%$$

$$\text{The reliability of the set of gyroscopes} = 99.9163629\%$$

In Figure 8, the reliability of all components is presented in two states: without consideration of common cause failures and with consideration of common cause failures. According to the figure, there is a difference between the two states in the three sections: the set of pressure sensors, the set of flow sensors, and the set of gyroscopes. This difference is bigger in the set of flow sensors, and it is small in the two other sets. The reason for this difference is the reliability value of components. The smaller the reliability of components is, the bigger the difference between the state of considering common cause failures and the state of not considering common cause failures will be. As a result, common cause failures have significant impact on the subsystems whose components have a reliability rate of lower than 90%.

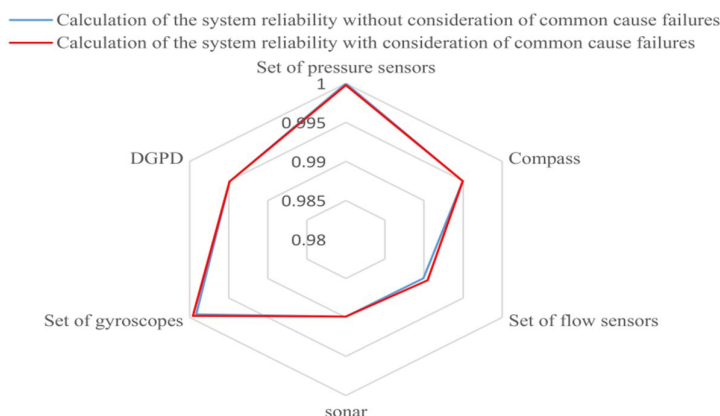

Fig . 8. The reliability of all components is presented in the states of without consideration of common cause failures and with consideration of common cause failures

According to the calculation of the reliability of series systems, reliability of the input of the dynamic positioning system of the submarine, including pressure sensors, flow sensors, compasses, DGPS, gyroscopes, and Sonar, is equal to:

$$R_{Input} = R_{Pre} \cdot R_{curr} \cdot R_{Com} \cdot R_{DGPS} \cdot R_{Gyro} \cdot R_{sona} = 96.3413067\%$$

However, if we calculate the system reliability without consideration of common cause failures, it will be equal to:

$$R = 96.95729849 \%$$

Figure 9 compares these two values, obtained by the two calculation methods.

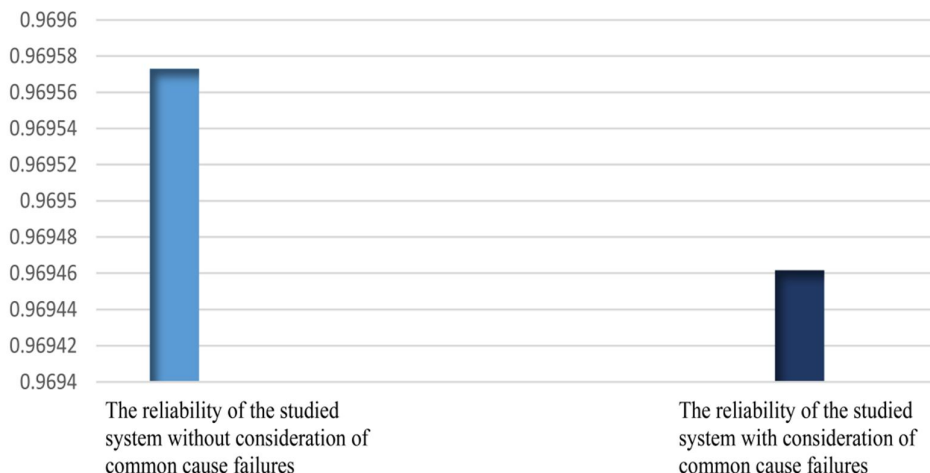

Fig . 9. Comparing the system reliabilities in the states of without consideration of common cause failures and with consideration of common cause failures

By comparing these two values, the impact of dependency on the system reliability is obtained, which is equal to E_D , and in the studied system, it is equal to:

$$E_{D_1} = 0.011141525\%$$

Given that the impact of dependency is a small (little) amount in the studied system, two points should be taken into consideration. First, this value may be small, but it is of particular importance due to the severity of the impact of its occurrence, which affects the whole system. This fact is also expressed via the technique of analyzing the potential failure modes and the

results. i.e., in addition to the possibility of the occurrence of failure, the severity of its occurrence is important too. Second, the reason why this value is small in the system under study is that the reliability of dependent components is very high. If the reliability of dependent components is lower, this difference will also be greater and more tangible.

To find out the effect of common cause failures on reliability of the system under study, analysis of the sensitivity will be dealt with, such that level of such a variable effect (level of effect on common cause failures) will be studied in

different circumstances in system reliability and the results be analyzed.

6. Sensitivity Analysis:

To analyze the sensitivity, basic variables will be considered in two other circumstances (The reliability amount of components with dependencies). Reliability of the components with dependencies is considered %90 in the second case regarding measurement. In the third condition regarding measurement, reliability of the components with dependencies is considered %80. With the help of such an analysis, effect of dependency level (common cause failure) will be measured in system reliability regarding different values.

In the second state, the reliability of dependent components, including pressure sensors, flow sensors, and gyroscopes, is assumed to be 90%. It should be mentioned that the dependency of

components is assumed the same initial value. In this state, the impact of dependency on the system reliability is equal to:

$$E_{D_2} = 0.38\%$$

In the third state, the reliability of dependent components, including pressure sensors, flow sensors, and gyroscopes, is assumed to be 80%. It should be mentioned that the dependency of components is assumed the same initial value. In this state, the impact of dependency on the system reliability is equal to:

$$E_{D_3} = 4.4032\%$$

According to sensitivity analysis in figure 10, the effect level of dependent failures (common cause failures) is provided according to considered assumptions in the studied system reliability.

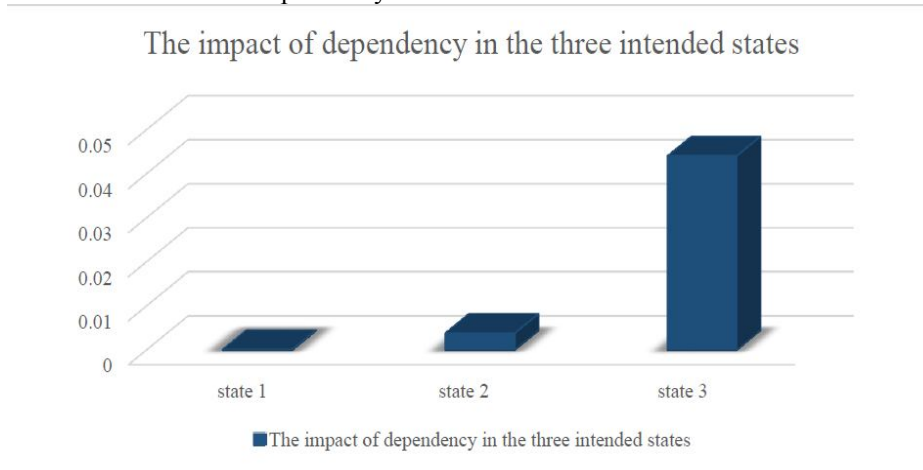

Fig. 10. The impact of dependency on the three intended states

7. Conclusion

In this study, first, we dealt with system identification with the aid of product breakdown structure (PBS) and functional flow block diagram (FFBD) techniques. In the analysis and identification of the system under study, the presence of dependent failures was detected, and by investigating the nature of the subsystems in which dependencies existed, the system's dependent failure was determined to be a kind of common cause failures. Then, system reliability was measured thanks to reliability block diagram. According to the nature of the system and with the help of IEC 61508, dependency of the system under the study, which was of common cause failure, was considered in measurements and an accurate amount of system reliability was determined.

In this study, when we compare the value of reliability, by taking into account the system dependency, which is a type of common cause failures in the studied system, and the value of system reliability without considering the system dependency, we noticed that there is a difference between these values, and this difference is of particular importance in sensitive systems.

It has been shown regarding sensitivity analysis that if subsystems with dependencies have less reliability, effect level of dependent failures (common cause failures) will go higher in system reliability. If reliability of the components has dependencies lower than % 90, effect level of such failures will be significant.

It should be noted that failure effect of common cause was considered for the first time in the country in this research in measuring reliability of a system (stability system input of dynamic

situation) and level of such effect was studied in different cases by the help of sensitivity analysis.

8. Limitations of The Study

The main limitation of this study is the value of the reliability of the system components, which has been available to researchers in an estimated form due to the nature of the studied system, which is a military system. It should be noted that this paper is taken from a Master's thesis at Malek-Ashtar University of Technology.

References

- [1] Luzia Penha F. A. M. D., Bayesian Estimation of Reliability of the Electronic Components Using Censored Data from Weibull Distribution: Different Prior Distributions, *International Journal of Industrial Engineering & Production Research*, Vol. 25, No. 4, (2014), pp. 257-268.
- [2] Jalali Naini S. G., Aryanezhad M. B., Jabbarzadeh A & Babaei H., Condition Based Maintenance for Two-Component Systems with Reliability and Cost Considerations, *Internattionall Journall off Industtriall Engiineeriing & Producttiion Research*, Vol. 20, No. 3, (2009), pp. 107-116.
- [3] Endrenyi J Reliability Modeling in Electric Power Systems. John Wiley and Sons (1978).
- [4] Billinton R, Allan R., Reliability Evaluation of Power Systems. Plenum Press, New York, (1984).
- [5] Sharifi M, Gholami M, Mazinan H, Karbasian M, Sharifi M H., Reliability Engineering. Omid Enqelab, (2012).
- [6] Movahedi Y, Dolatkah M, Karbasian M, Rasty V., Design and Development of the Pattern to Assign and Estimate the Reliability of Complicated Systems by Bayesian Network Method, Case Study: A High Technology Camera, *International Journal of Industrial Engineering & Production Management*; Vol. 24, No. 4, (2014), pp. 437-448.
- [7] Karbasian M, Ghouchani M M., Reliability Allocation. Publishers Naghoos, (2011).
- [8] Saleh J H, Marais K., Highlights from the Early History of Reliability Engineering, Reliability Engineering and System Safety. Vol. 91, No. 2, (2006), pp. 249-256.
- [9] Karbasian M, Tabatabaei L., Introduction to Reliability, Publisher's Arkan Danesh, Second Edition. (2014).
- [10] Juran J, Gryna F., Quality Control Handbook. Fourth Edition, McGraw-Hill, New York, (1988).
- [11] Denson W., The History of Reliability Prediction. *IEEE TRANSACTIONS ON Reliability*, Vol. 47, No. 3, (1998), pp. 321-328.
- [12] Marvin R, Arnljot H., A System Reliability Theory. John Wiley & Sons, Inc., Hoboken, New Jersey, USA, 2. Edition, (2004).
- [13] Eghbali A., Calculation and analysis of reliability of dynamic positioning system of a submarine with regard to dependencies in dissimilar sub-systems, Master Thesis in Malek-Ashtar University of Technology, Department of Industrial Engineering, (2016).
- [14] Jamshidi, R. Seyyed Esfahani M M., Human resources scheduling based on machines maintenance planning and human reliability level, *Internattionall Journall off Industtriall Engiineeriing & Producttiion Research*, Vol. 26, No. 1, (2015), pp. 27-38.
- [15] Humphreyes P, Johnston B D., Dependent Failure Procedure Guide SRD-R-418. United Kingdom Atomic Energy Authority, Safety and Reliability Directorate, March, (1987).
- [16] Giuseppe M., Integrating Safety Analysis Techniques, Supporting Identification of Common Cause Failures. Doctor of Philosophy thesis, University of York, Department of Computer Science, (2000).
- [17] Wenjing S., Determination of Beta-factors for Safety Instrumented Systems. Master Thesis in Norwegian University of Science and Technology, Department of Production and Quality Engineering, (2013).

- [18] Yang Y-J, Huang H-Z, Liu Y, Zhu S-P, Peng W., Reliability analysis of electrohydraulic servo valve suffering common cause failures. *Journal of Eksploatacja i Niezawodnosć – Maintenance and Reliability*, Vol. 16, No. 3, (2014), pp. 354-359.
- [19] Borcsok J, Holub P., Different approaches for probability of common cause failure on demand calculations for safety integrity systems. *Proceedings of International Conference on Computer Systems and Applications*, (2008), pp. 1052-1057.
- [20] Karbasian M., Rostami Mehr M & Agharajabi M., Improvement of the Reliability of Automatic Manufacture Systems by Using FTA Technique, *Internattionall Journall off Industriall Engiineeriing & Productiion Research*, Vol. 23, No. 2, (2012), pp. 85-89.
- [21] NUREG-75/014., Reactor safety: An assessment of accident risk in us commercial nuclear power plants, Technical report. U.S. Nuclear Regulatory Commission, WASH-1400, Washington DC, (1975).
- [22] Haugea S, Hokstada P, Håbrekke S, Lundteigen M A., Common Cause Failures in Safety-Instrumented Systems: Using Field Experience from the Petroleum Industry. *Journal of Reliability Engineering & System Safety*, (2016), pp. 151-3445.
- [23] Smith A M, Watson I A., Common cause failures - a dilemma in perspective. *Reliability Engineering. Journal of Reliability Engineering*. Vol. 1, No. 2, (1980), pp. 127-142.
- [24] Yong S, Lin M., Estimating interactive coefficients for analysing interactive failures. *Journal of Eksploatacja i Niezawodnosć – Maintenance and Reliability*. Vol. 2, No. 46, (2010), pp. 67-72.
- [25] International standard IEC 61508-6 Functional safety of electrical /electronic /programmable electronic safety-related systems. (2010). Edition 2.0.
- [26] Hammoud S., Ship Motion Control Using Multi-controller Structure. *Journal of Maritime Research*, Vol. 55, (2012), pp. 184-190.
- [27] Sandaruwan D, Kodikara N, Keppitiyagama C, Rosa R., A Six Degrees of Freedom Ship Simulation System for Maritime Education. *The International Journal on Advances in ICT for Emerging Regions*, Vol. 3, No. 2, (2010), pp. 34-47.
- [28] Sørensen A J., A survey of technology advances and future perspectives of dynamic positioning systems. In *Plenary lecture in proceedings of the IFAC conference on control applications in marine systems, Rostock-Warnemünde, Germany*. Vol. 35, No. 1, (2010), pp. 123-136.

Follow This Article at The Following Site

Karbasian M, Eghbali Babadi A, Hasani F. Calculation and Analysis of Reliability with Consideration of Common Cause Failures (CCF) (Case Study: The Input of the Dynamic Positioning System of a Submarine). *IJIEPR*. 2017; 28 (2) :175-187
URL: <http://ijiepr.iust.ac.ir/article-1-730-en.html>
DOI: 10.22068/ijiepr.28.2.175

