

RESEARCH PAPER

Direct Aperture Optimization for Intensity Modulated Radiation Therapy: Two Calibrated Metaheuristics and Liver Cancer Case Study

Ali Fallahi¹, Mehdi Mahnam^{2*} & Seyed Taghi Akhavan Niaki³

Received 14 February 2022; Revised 26 February 2022; Accepted 15 March 2022;
© Iran University of Science and Technology 2022

ABSTRACT

Integrated treatment planning for cancer patients has high importance in intensity modulated radiation therapy (IMRT). Direct aperture optimization (DAO) is one of the prominent approaches used in recent years to attain this goal. Considering a set of beam directions, DAO is an integrated approach to optimize the intensity and leaf position of apertures in each direction. In this paper, first, a mixed integer-nonlinear mathematical formulation for the DAO problem in IMRT treatment planning is presented. Regarding the complexity of the problem, two well-known metaheuristic algorithms, particle swarm optimization (PSO) and differential evolution (DE), are utilized to solve the model. The parameters of both algorithms are calibrated using the Taguchi method. The performance of two proposed algorithms is evaluated by 10 real patients with liver cancer disease. The statistical analysis of results using paired samples t-test demonstrates the outperformance of the PSO algorithm compared to differential evolution, in terms of both the treatment plan quality and the computational time. Finally, a sensitivity analysis is performed to provide more insights about the performance of algorithms and the results revealed that increasing the number of beam angles and allowable apertures improve the treatment quality with a computational cost.

KEYWORDS: Radiation therapy treatment planning; Intensity modulated radiation therapy; Direct aperture optimization; Particle swarm optimization; Differential evolution.

1. Introduction

Radiation therapy is one of common methods for cancer treatment all over the world, where about 66 percent of cancer patients experience at least one stage of the treatment procedure [1]. This treatment method is divided into external and internal types, according to the radiation source position. IMRT is among the most efficient methods of external radiation therapy. In this method, the radiation is directed to the head of the machine, which is called gantry through a linear accelerator. There is a multi-leaf collimator (MLC) device on the head of the gantry, which

shapes and modulates the intensity by its metal leaves. In IMRT, the goal is to deliver the prescribed dose to the cancerous cells while minimizing the dose to the healthy structures.

The trial-and-error method has been the initial approach to generate a treatment plan in IMRT, which results time-consuming and low-quality plans. According to its deficiency, the researchers in this area were prompted to provide treatment schemes with mathematical optimization approaches. Three main optimization sub-problems are defined as: (1) Beam angle optimization (BAO) to determine the position of the gantry for dose irradiation, (2) Fluence map optimization (FMO), to specify the dose intensity map in each angle, and (3) MLC leaf sequencing (LS) to determine a set of apertures and their intensity and shapes for delivering the fluence map [2]. Each subproblem has been studied from various points of view in recent years. [3] presented the beam angle optimization in which the simulated annealing (SA) algorithm was utilized as the solution approach. They computed

*

Corresponding author: Mehdi Mahnam
m.mahnam@iut.ac.ir

1. Department of Industrial Engineering, Sharif University of Technology, Tehran, Iran.
2. Department of Industrial and Systems Engineering, Isfahan University of Technology, Isfahan, 84156-83111 & Center for Optimization and Intelligent Decision Making in Healthcare Systems (COID-Health), Isfahan University of Technology, Isfahan, 84156-83111, Iran.
3. Department of Industrial Engineering, Sharif University of Technology, Tehran, Iran.

the fluence map of each direction by a fast filtered backprojection exact algorithm. [4] designed a parallelized levy-firefly metaheuristic algorithm to solve FMO. [5] proposed a game theory approach to make a trade-off between the absorbed dose of tumor and healthy structures in the FMO problem [6] addressed nonconvex dose-volume constraints in FMO by applying some new exact algorithms.

The main limitation of the hierarchical approach in three above sub-problems is not considering the apertures decisions, i.e., the feasibility leaf sequencing, in the intensity and fluence map optimization. [7] considered this drawback and proposed the direct aperture optimization (DAO) problem for the first time. DAO integrates FMO and LS subproblems and optimize the apertures' intensity and shape in an integrated way. In recent years, more researchers paid attention to DAO. [8] developed a genetic algorithm (GA) for DAO problem. [9] presented a deterministic algorithm for optimizing an approximation of DAO, and compared the performance of their method to a SA algorithm. [10] proposed a rapid solution algorithm using a piecewise matrix-based engine. They examined this method on the SA algorithm and the computational time is reduced significantly. [11] used the column generation algorithm as the solution method of DAO for the first time. After that, [12] tried to speed up the column generation method by parallelizing the algorithm using graphics processing unit (GPU). [13] used SA to find near-optimal solutions of DAO, and showed that DAO has significantly better performance than the classic sequential

approach. [14] presented a hybrid algorithm for DAO, in which a genetic algorithm (GA) optimized the shapes and conjugate gradient found the optimal intensity of apertures. [15] designed a multi-objective GA algorithm for DAO with an intensity-based and a dose-based objective function. [16] presented a fast inverse dose optimization algorithm for DAO, in which direct matrix inversion used to find the optimum solution. They validated the performance of this algorithm by comparing it to the interior point method. [17] developed a robust direct aperture optimization model to consider the breathing motion uncertainty during the treatment process. Recently, [18] presented a stochastic local search algorithm with two neighborhood structures to find the best apertures shapes and intensities. The proposed heuristic and metaheuristic approaches have also been used for other radiation therapy techniques such as volumetric modulated arc therapy (VMAT), Cyberknife, and Tomotherapy [1, 19, 20]. We refer the interested readers to comprehensive review papers in the literature for more details [2, 7, 21].

Despite the development of various optimization approaches, there is not much discussion of efficient metaheuristic algorithms for the DAO complex problem. This is the motivation of current research, where we try to present a mixed-integer nonlinear mathematical model for DAO, and design two efficient metaheuristic algorithms, DE and PSO as the solution approaches for the first time. Table 1 compares the current works against the previous researches in the literature.

Tab. 1. The features of the relevant works in IMRT literature

Paper	Year	BAO	FMO	LS	Approach	Case study
Pugachev, et al. [3]	2000	✓	✓	✗	SA, fast filtered backprojection	Phantom
Shepard, et al. [13]	2002	✗	✓	✓	SA	Prostate, Head and neck, Phantom
Cotrutz and Xing [8]	2003	✗	✓	✓	GA	Phantom
Bingzhou, et al. [15]	2008	✗	✓	✓	GA	Phantom
Men, et al. [12]	2010	✗	✓	✓	Column generation	Prostate, Head and neck
Cao, et al. [14]	2014	✗	✓	✓	Hybrid GA and conjugate gradient	Head and neck
Kalantzis, et al. [4]	2016	✗	✓	✗	GPU-based levy-firefly	Head and neck, Prostate
Nguyen, et al. [9]	2017	✗	✓	✓	Primal-dual, SA	Glioblastoma multiforme, Head and neck, Lung
Zeng, et al. [10]	2018	✗	✓	✓	Modified SA	Liver, Prostate, Head and neck, Phantom
MacFarlane, et al. [16]	2019	✗	✓	✓	Fast inverse dose optimization	Liver, Prostate, Head and neck, Phantom
Sadeghnejad Barkousaraie, et al. [22]	2020	✓	✓	✗	Deep learning	Prostate
Ripsman, et al. [17]	2021	✗	✓	✓	Candidate plan generation heuristic	Breast
Cáceres, et al. [18]	2021	✗	✓	✓	Stochastic local search	Prostate
Maass, et al. [6]	2022	✗	✓	✗	Exact algorithms	Prostate
Current paper	2022	✗	✓	✓	DE, PSO	Liver

The rest of this paper is organized as follows. In section 2, the DAO problem is defined, and a mixed integer-nonlinear mathematical model is presented. In section 3, two metaheuristic algorithms are proposed to solve the problem. In section 4, the parameters of algorithms are calibrated by Taguchi's design of experiments, and the performance of these algorithms is compared by applying them to 10 patients with liver cancer. In addition, a sensitivity analysis is provided in this section to give more insights into the performance of the model and algorithms. In section 5, the managerial insights are discussed. Finally, in Section 6, the paper is concluded, and some directions for future research are suggested.

2. Problem Description and Mathematical Formulation

In the direct aperture optimization problem, the set of beam directions B are given. Each direction $b \in B$ is discretized into small rectangular grids, so called beamlets. By moving the left and right leaves of MLC, we can open or close a beamlet (r, c) , in the row r and column c of MLC. In addition, all the structures of the patient, denoted by $s \in \{1, \dots, S\}$, are decomposed into small cube elements, called voxels denoted by $v \in \{1, \dots, V_s\}$. There is a dose correlation factor parameter $D_{(r,c)v}^b$ indicating the received dose by voxel v in 1 Gy/MU, when the beamlet (r, c) in beam b is on. The goal is to determine a set of MLC apertures per beam direction and optimizing the intensity of each aperture, so that the overdose and underdose of tumor and the overdose of healthy structures are minimized. To this end, a mixed-integer nonlinear model is provided as follows.

Let

- S be the index set of structures, $s \in \{1, \dots, S\}$;
- V be the index set of all structures;
- V_s be the index set of structure s ;
- B be the index set of all beam directions
- A_b be the index set of available apertures in beam angle b , $a \in \{1, \dots, A_b\}$;
- R be the index set of available rows in an aperture, $r \in \{1, \dots, R\}$;
- C be the index set of available columns in an aperture, $c \in \{1, \dots, C\}$.

Moreover, the following parameters are considered in the model as follows:

U_s	The overdose penalty factor of structure s
L_s	The underdose penalty factor of structure s
AL	The number of allowable apertures in a beam direction
IL	The upper limit for the intensity of each aperture
\overline{P}_s	The desired upper limit on the received dose by voxels of structure s
\underline{P}_s	The desired lower limit on the received dose by voxels of structure s
$D_{(r,c)v}^b$	The dose deposition coefficient for the irradiated dose from beamlet (r,c) from direction b to voxel v

The decision variables of the problem are defined as:

i_a	The intensity of irradiated dose from aperture a
y_a	A binary variable; if $i_a > 0$, 1 and otherwise 0
le_r^a	The position of left leaf in row r of aperture a
ri_r^a	The position of right leaf in row r of aperture a
w_a^{rc}	A binary variable; if beamlet (r, c) of aperture a is open, 1 and otherwise 0
q_v	The delivered dose to voxel v

The model is formulated as follow:

$$\text{Min } F(q) = \sum_{s=1}^S \sum_{v=1}^{V_s} U_s (q_v - \overline{P}_s)_+^2 + L_s (\underline{P}_s - q_v)_+^2 \quad (1)$$

Subject to:

$$\sum_{a \in A_b} y_a \leq AL \quad \forall a \in A_b, \forall b \in B \quad (2)$$

$$le_r^a \leq ri_r^a - 1 \quad \forall a \in A_b, \forall b \in B, \forall r \in R \quad (3)$$

$$1 \leq ri_r^a \leq C + 1 \quad \forall a \in A_b, \forall b \in B, \forall r \in R \quad (4)$$

$$cw_a^{rc} \leq ri_r^a - 1 \quad \forall a \in A_b, \forall b \in B, \forall r \in R, \forall c \in C \quad (5)$$

$$(C + 1 - c)w_a^{rc} + le_r^a \leq C \quad \forall a \in A_b, \forall b \in B, \forall c \in C, \forall r \in R \quad (6)$$

$$\sum_{c \in C} w_a^{rc} = ri_r^a - le_r^a - 1 \quad \forall a \in A_b, \forall b \in B, \forall c \in C \quad (7)$$

$$y_a, w_a^{rc} \in \{0,1\} \quad \forall a \in A_b, \forall b \in B, \forall r \in R, \forall c \in C \quad (8)$$

$$le_r^a, ri_r^a \in Z_+^{R \times |A|} \quad \forall a \in A_b, \forall b \in B, \forall r \in R \quad (9)$$

$$i_a \in R_+^{|A|} \quad \forall a \in A_b, \forall b \in B \quad (10)$$

The quadratic objective function (1) penalizes the under-dose and over-dose for the target volume (PTV) and healthy structures, which is one of the convex objectives in this research area [2, 23]. Constraints (2) limit the number of apertures in each beam direction to control the delivery time. The overlapping of the right leaf and left leaf in each row of MLC aperture is restricted by constraints (3). Constraints (4) define the possible positions for the right leaf of MLC in each aperture row. Constraints (5) and (6) ensure that there is no dose irradiation from the blocked beamlets by left and right leaves. Constraints (7) guarantee the continuity of open beamlets in each aperture row. Constraints (8) - (10) specify the type of decision variables.

This model falls into the category of constrained nonlinear optimization problems that cannot easily be solved using commercial solvers or exact algorithms.

3. Solution Method

The complexity of DAO motivates the researchers to customize heuristic and metaheuristic algorithms for this problem. To the best of the authors' knowledge, two highly efficient PSO and DE metaheuristic algorithms have not yet been applied to DAO. Both

algorithms are simple and many studies have demonstrated promising performance of these algorithms in a wide range of optimization problems [24, 25].

The first challenge in this problem is a hierarchical dependency between the decision variables, i.e., number of apertures, intensity of apertures, and leaves positions. For example, the shape of an aperture is influenced by its direction. Therefore, we consider all the hierarchical relationships in both algorithms. Also, the quadratic objective function (1) is considered as the fitness function.

3.1. Particle swarm optimization

PSO is a nature-inspired population-based metaheuristic algorithm, first introduced by [26]. The algorithm imitates the social behavior of birds and has great performance in solving a wide range of complex optimization problems [27-31]. PSO starts the first iteration ($t = 1$) with an initial random population ($Npop$) of solutions, each single solution is called particle ($X_{i,t}$). The direction of particles in each iteration is dynamically determined by a velocity variable ($V_{i,t+1}$), according to Equation (11):

$$V_{i,t+1} = wV_{i,t} + c_1r_1(P_{best} - X_{i,t}) + c_2r_2(G_{best} - X_{i,t}) \quad (11)$$

where P_{best} is the previous best position of particle i , and G_{best} is the previous best position of all particles. The parameter w is the inertial weight parameter, which is modified in each iteration by multiplying to a parameter w_{damp} . Parameters c_1 and c_2 are learning factors for managing the impact of P_{best} and G_{best} , and r_1 and $r_2 \in [0,1]$ are two randomly generated numbers. The new position of each particle is updated by adding the current velocity to the previous position:

$$X_{i,t+1} = X_{i,t} + V_{i,t+1} \quad (12)$$

The PSO algorithm is run until the termination condition, i.e., maximum number of iterations (Max_{it}), is met.

3.2. Differential evolution

Differential Evolution is a population-based algorithm first proposed by [32] in 1995. This metaheuristic has recently attracted much attention due to its simplicity and efficiency [33-36]. DE has three main operators as mutation, crossover, and selection. To start, DE generates a random initial population of target vectors with size $Npop$. Next, the mutation operator is implemented for each variable of target vector to produce a new mutant vector as follows:

$$V_{ji,t+1} = X_{a_1j,t} + F(X_{a_2j,t} - X_{a_3j,t}) \quad \forall j = 1, \dots, D \text{ and } i = 1, \dots, Npop \quad (13)$$

where X_{a_1} , X_{a_2} and X_{a_3} are three randomly selected target vectors. After that, the crossover

$$U_{ji,t+1} = \begin{cases} V_{ji,t+1} & \text{if } rand(j) \leq P_{cr} \text{ or } j = randi(i) \\ X_{ji,t} & \text{Otherwise} \end{cases} \quad (14)$$

where $P_{cr} \in [0,1]$ is the crossover probability. $rand(j) \in [0,1]$ and $randi(i) \in [0,i]$ are continuous and integer random numbers,

$$X_{i,t+1} = \begin{cases} U_{i,t+1} & \text{if } f(U_{i,t+1}) \leq f(X_{i,t}) \\ X_{i,t} & \text{Otherwise} \end{cases} \quad (15)$$

The maximum number of iterations (Max_{it}) is taken into account as the stop condition of DE in this study, similar to PSO.

3.3. Constraint handling

Constraint handling is a big challenge for metaheuristic algorithms. Several constraint methods are used in the literature for metaheuristics, e.g., penalty functions, decoders, special operators [37, 38]. To provide practical results and keep the quality of solutions, the operators in our proposed algorithms ensure all solutions' feasibility during the procedure of the algorithm.

4. Clinical Case Study

4.1. Data description

We analyze the performance of proposed algorithms using the TROTS dataset provided at Erasmus University Medical Center Rotterdam [39]. We consider 10 cases with liver cancer from this dataset. For each case, the goal is to deliver 75 Gy dose to at least 95% of the tumor while other healthy structures receive the minimum dose. The desired dose is planned to deliver in 15 fractions. Other healthy structures are the heart, esophagus, stomach, spinal cord, duodenum, pancreas, liver minus clinical target volume

operator is performed to combine the mutant vector and related individual as:

respectively. Finally, the selection of target vector for the next generation is as follow:

(CTV), and kidney. The algorithms are implemented in MATLAB R2017a programming language and run on a supercomputer with 64 GB ram and Intel Xeon E312 CPU.

4.2. Parameter calibration

As the performance of metaheuristics is highly dependent on the input values, we employed the Taguchi method to calibrate the parameters. Taguchi divides the affecting parameters to signal (S) and noise (N) factors. This method uses orthogonal arrays to identify a combination of inputs that maximize the signal to noise ratio. For a minimization problem, this ratio is as follow:

$$S/N = -10 \log_{10} \left(\frac{1}{n} \sum_{i=1}^n z_i^2 \right) \quad (16)$$

where n is the number of replications and z_i is the objective function value in i^{th} replication. We consider six parameters of PSO and four parameters of DE to be calibrated by the Taguchi method. We use L^{27} and L^9 orthogonal arrays for PSO and DE, respectively. The sample size of each array is three. This method is implemented by Minitab 17 statistical software, and the results are graphically presented in Figure 1 and Figure 2.

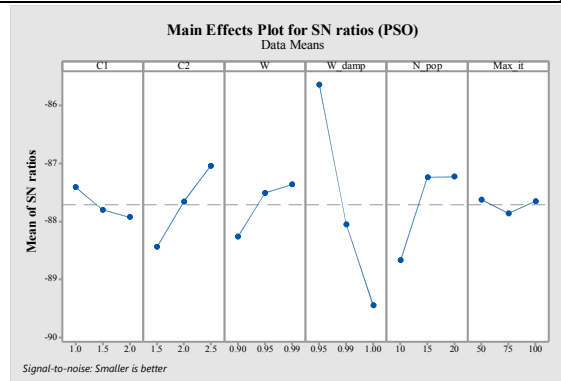

Fig. 1. Optimal parameter level for PSO

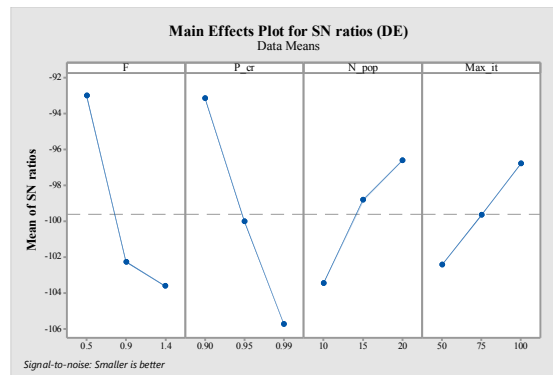

Fig. 2. Optimal parameter level for DE

Based on the Taguchi experiments, the optimal parameters level of PSO are $c_1 = 1$, $c_2 = 2.5$, $w = 0.99$, $w_{damp} = 0.95$, $N_{pop} = 20$, and $Max_{it} = 50$. For DE algorithm, $F=0.5$, $P_{cr} = 0.9$, $N_{pop} = 20$, and $Max_{it} = 100$ are obtained parameters levels.

4.3. Performance comparison

The algorithms are implemented for 10 cases of TROTS. The objective function value and CPU time are the considered measures for evaluating the algorithms. Table 2 summarizes the obtained results. It is clear that the PSO outperforms the DE in all cases with respect to both measures.

Tab. 2. Computational results of algorithms

#Case	Objective function		CPU Time (Min)	
	PSO	DE	PSO	DE
1	20667.86	37907.97	6.81	41.17
2	18070.94	42761.19	7.01	40.56
3	38895.05	60569.63	9.46	48.28
4	41809.26	68769.41	7.32	39.56
5	28435.55	45453.45	7.13	40.50
6	37199.40	53625.34	7.74	39.58
7	53662.63	78081.41	9.36	42.48
8	54029.09	75176.10	9.39	41.37
9	48861.29	57743.10	8.69	43.64
10	33142.13	49753.74	8.66	44.53

The convergence curves of algorithms for Case 1 are shown in Figures 3 and 4. As can be seen, the

PSO algorithm converges to better solutions faster and in a fewer number of iterations.

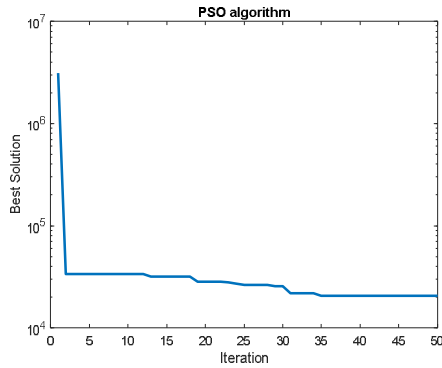

Fig. 3. Convergence curve of PSO algorithm

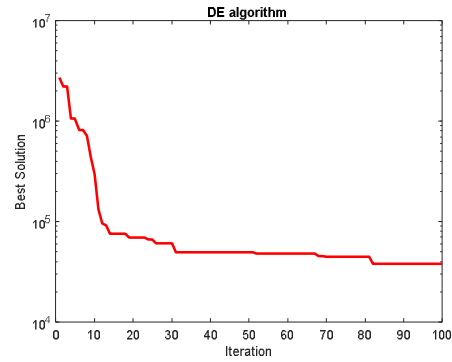

Fig. 4. Convergence curve of DE algorithm

Moreover, we use the paired samples T-test to statistically analyze the performance of algorithms in terms of solution quality and time. In these tests, the null hypothesis is no difference between two proposed algorithms, while the

alternative is the significant difference. We provide the results of paired samples T-test in Tables 3 and 4, based on the objective function and CPU time, respectively.

Tab. 3. The results of paired samples t-test for the differences of the objective function of algorithms

Source	N	Mean	StDev	SE Mean
PSO	10	37477	12676	4008
DE	10	56984	13708	4335
Difference	10	-19507	5334	1687

95% Confidence Intervale for mean difference: [-23322 , -15691], P-value=0.000

Tab. 4. The results of paired samples t-test for the differences of the CPU time of algorithms

Source	N	Mean	StDev	SE Mean
PSO	10	8.157	1.068	0.338
DE	10	42.167	2.702	0.854
Difference	10	-34.010	2.134	0.675

95% Confidence Intervale for mean difference: [-35.536, -32.484], P-value=0.000

The p -value for both tests was less than 0.05 and we can conclude, with at least 95% confidence, that algorithms' objective function and CPU time are significantly different. The boxplots of algorithms are shown in Figures 5 and 6, to

provide more insights. The PSO boxplot in both figures is lower and narrower, which indicates less variance of objective function and CPU time in this algorithm. This represents the robustness of PSO compared to DE in different cases.

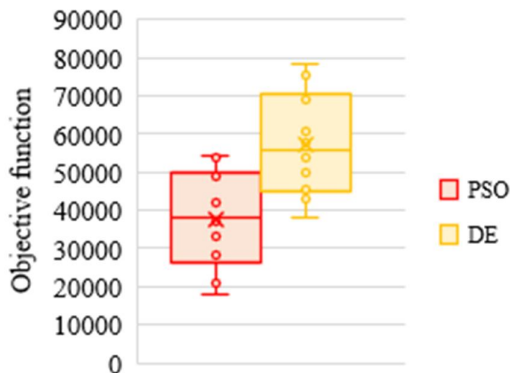

Fig. 5. The boxplot for objective function

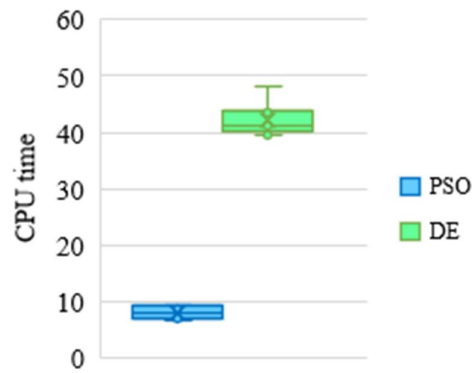

Fig. 5. The boxplot for CPU time

In addition, Dose Volume Histogram (DVH) is a tool that oncologists use to evaluate the quality of a treatment plan, practically. DVH curves specify the received dose level by different volumes of structures. For example, $V_u \leq v\%$ indicates that $v\%$ of the structure has received less or equal

than u Gy dose. For instance, the DVHs 11 structures obtained by two algorithms for case 1 is compared in Figure 7. Clearly, the overdose of tumor and healthy structures is less in the treatment plan of PSO.

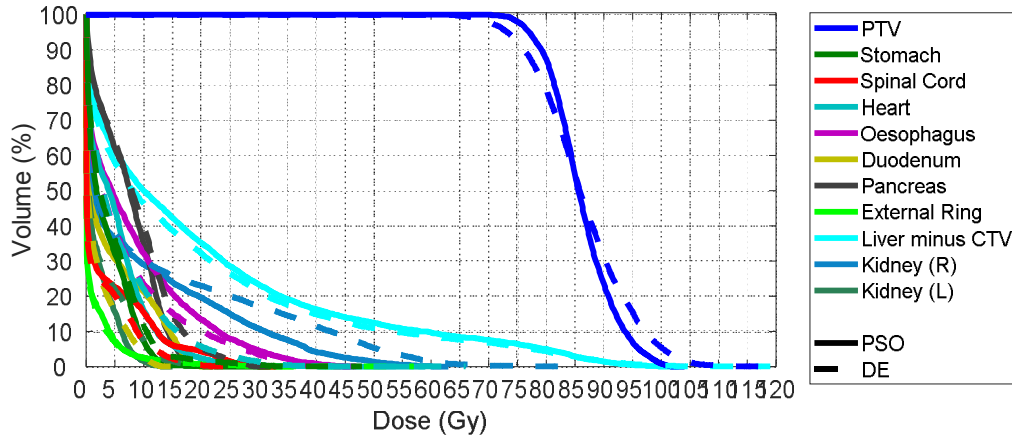

Fig. 7. DVH comparison of proposed algorithms

Finally, the CT scan of Case 1 for the obtained plans by PSO and DE are shown in Figures 8 and 9, respectively. Obviously, the maximum tumor overdose in the PSO solution is about 102 Gy,

while this value is about 118 Gy for the obtained solution by DE. Furthermore, the figures show that there is more dose leakage to healthy structures for the plan obtained by DE.

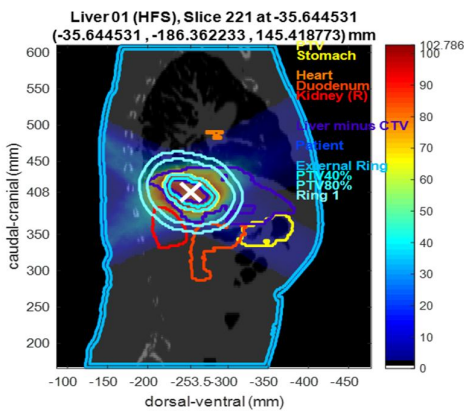

Fig. 8. CT scan for PSO Obtained Plan

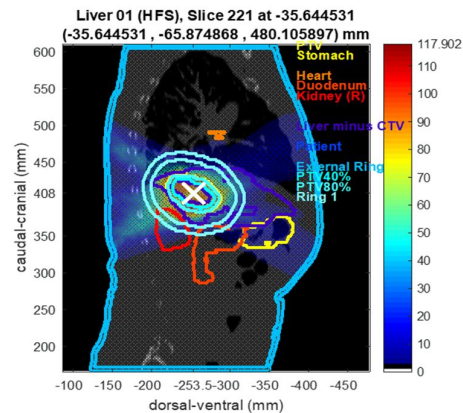

Fig. 9. CT scan for DE Obtained Plan

4.3. Sensitivity analysis

In this section, we provide sensitivity analyses to address the impact of the number of beam directions and allowable apertures per direction on the treatment plan quality and CPU time. We perform the sensitivity analysis on Case 1 of the data set. First, to investigate the influence of

available beam directions on the results, we consider a range of 3 to 5 for the number of beam angles. The results are presented in Table 5. Moreover, the impact of this parameter on the results of algorithms is graphically shown in Figures 10 and 11, respectively.

Tab. 5. Sensitivity of algorithms with respect to the number of beam directions

Number of beam angles	PSO algorithm		DE algorithm	
	Objective function	CPU time (Min)	Objective function	CPU time(Min)
3	1826199.45	2.95	1012210.73	18.29
5	279994.87	3.84	818056.53	17.98
7	181953.66	3.78	104906.09	23.97
9	26310.6	5.07	41526.82	29.15
11	24783.6	5.42	32739.95	34.4
13	21502.35	5.85	37042.54	39.34
15	20667.86	6.81	37907.97	41.17

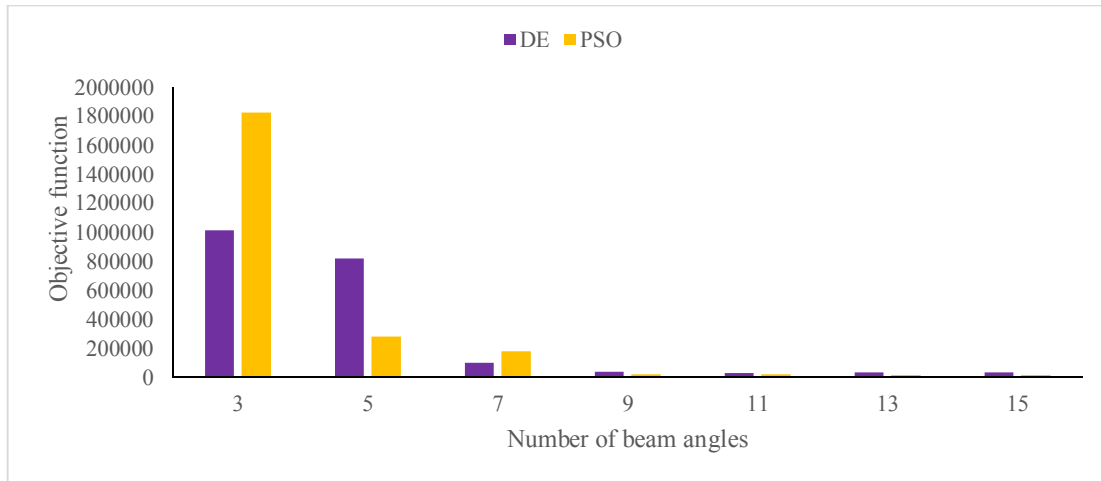

Fig. 10. The impact of the number of beam directions on the objective function of algorithms

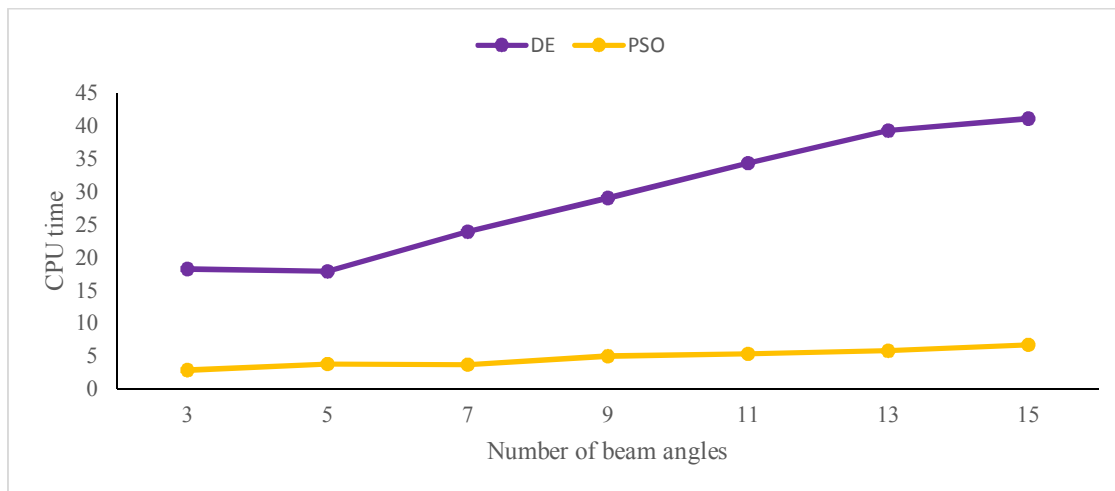

Fig. 11. The impact of the number of beam directions on the CPU time of algorithms

Clearly, increasing the number of beam directions provides additional search space and more flexibility and consequently results in better objective values. On the other hand, this leads the algorithms to be more time consuming for treatment plan optimize of all beam direction. Furthermore, the number of allowable apertures per direction is another important parameter of

the DAO problem to investigate. We consider 7 levels of allowable apertures from 3-15 to analyze the sensitivity of the outcomes of the algorithms. The obtained results are summarized in Table 6. In addition, these results are graphically depicted in Figures 12 and 13, schematically.

Tab. 6. Sensitivity of algorithms with respect to the number of allowable apertures

Number of allowable apertures	PSO algorithm		DE algorithm	
	Objective function	CPU time (Min)	Objective function	CPU time (Min)
3	13253.1646	2.56	4650216.77	11.37
5	22747.9788	3.18	1349129.02	17.35
7	32369.8526	3.74	323808.38	23.03
9	19195.8355	5.47	75598.52	29.35
11	20686.1537	5.85	42634.28	35.64
13	18576.7438	6.45	40864.06	38.59
15	20667.86	6.81	37907.97	41.17

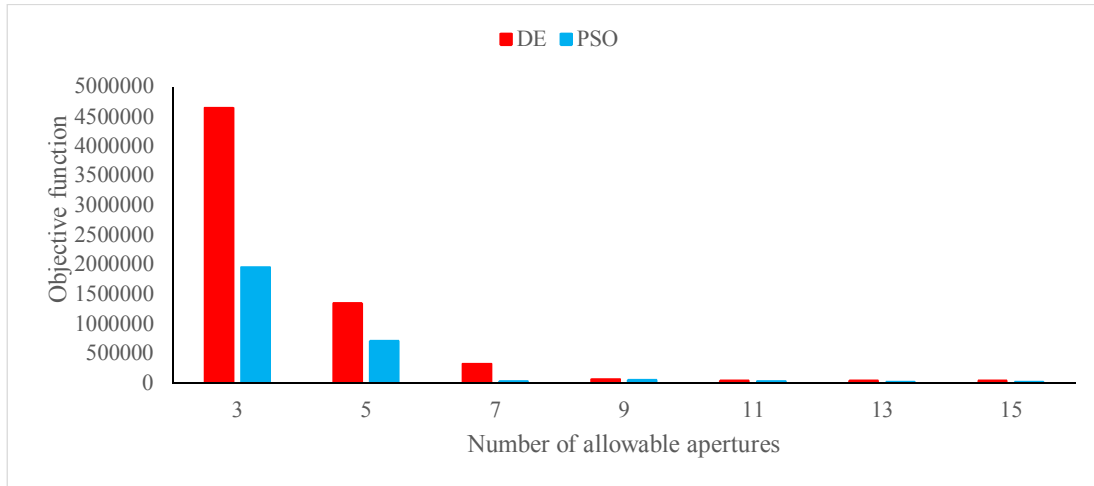

Fig. 12. The impact of the number of allowable apertures on the objective function of algorithms

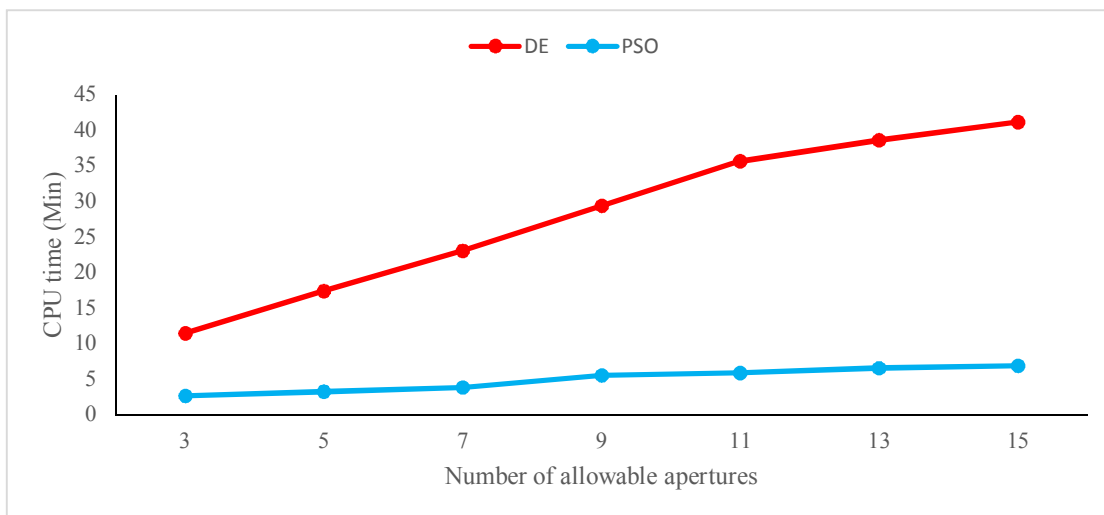

Fig. 13. The impact of the number of allowable apertures on the CPU time of algorithms

The results indicate that the effect of this parameter is similar to the number of beam angles parameter, where the algorithms found better solutions when the number of allowable apertures increased, but at the same time, it imposes a more computational cost to the metaheuristics.

5. Managerial Insights

Sequential planning is one of the main challenges in IMRT treatment planning, which is time-consuming and deteriorates the quality of the treatment plan. In recent years, DAO is used as a successful method to provide an integrated treatment plan in less possible time. PSO and DE

algorithms are designed in this research to solve this problem for the first time. The following managerial insights can be expressed based on the obtained results of the algorithms for 10 patients with liver cancer from the TROTS dataset:

- PSO is more powerful than differential evolution in solving of DAO problem for all liver cases of the TROTS dataset.
- Rising the number of beam angles positively affects the quality of the treatment plan for both metaheuristics.
- Rising the number of allowable apertures positively affects treatment plan quality for both metaheuristics.
- Rising the number of beam angles negatively affects the computational time of both metaheuristics.
- Rising the number of allowable apertures negatively affects the computational time of both metaheuristics.
- The DVH of algorithms shows that both algorithms can calculate the acceptable treatment plans which can be used by oncologists practically. In addition, the PSO has better performance than DE also regarding the DVH criteria.

6. Conclusion

In this research, the direct aperture optimization problem in IMRT treatment planning is investigated. This problem integrates the optimization of aperture intensities and leaf positions. A mixed-integer nonlinear mathematical models is presented to formulate this problem. Due to the nonlinearity of the problem, two efficient metaheuristic algorithms, PSO and DE as two powerful metaheuristics, were designed specifically with special features of DAO. The parameters of both algorithms were tuned by the Taguchi design of experiments method. The performance of algorithms was analyzed by applying the algorithms to 10 real liver cancer cases from the TROTS data set. The statistical analyses of results show the superior performance of PSO. Moreover, sensitivity analysis are performed on two important parameters of the models to provide managerial insights. The results show that that increasing the number of beam directions and allowable apertures enhance the solution quality of DE and PSO. However, the rising of these parameters rises the CPU time of algorithms. For future research directions, hybridization of presented metaheuristics or developing the adaptive version and making a comparison with the current results seems interesting. In addition, the current

algorithms can be applied to other problems in IMRT, such as BAO and FMO.

References

- [1] K. Akartunalı, V. Mak-Hau, and T. Tran, "A unified mixed-integer programming model for simultaneous fluence weight and aperture optimization in VMAT, Tomotherapy, and Cyberknife," *Computers & Operations Research*, Vol. 56, (2015), pp. 134-150.
- [2] M. Ehrgott, Ç. Güler, H. W. Hamacher, and L. Shao, "Mathematical optimization in intensity modulated radiation therapy," *Annals of Operations Research*, Vol. 175, No. 1, (2010), pp. 309-365.
- [3] A. Pugachev, A. Boyer, and L. Xing, "Beam orientation optimization in intensity modulated radiation treatment planning," *Medical Physics*, Vol. 27, No. 6, (2000), pp. 1238-1245.
- [4] G. Kalantzis, C. Shang, Y. Lei, and T. Leventouri, "Investigations of a GPU-based levy-firefly algorithm for constrained optimization of radiation therapy treatment planning," *Swarm and Evolutionary Computation*, Vol. 26, (2016), pp. 191-201.
- [5] P. G. Saghand and H. Charkhgard, "A cooperative game solution approach for intensity modulated radiation therapy design: Nash Social Welfare optimization," *Physics in Medicine & Biology*, Vol. 66, No. 7, (2021), p. 075011.
- [6] K. Maass, M. Kim, and A. Aravkin, "A nonconvex optimization approach to IMRT planning with dose-volume constraints," *INFORMS Journal on Computing*, (2022).
- [7] D. M. Shepard, M. C. Ferris, G. H. Olivera, and T. R. Mackie, "Optimizing the delivery of radiation therapy to cancer patients," *Siam Review*, Vol. 41, No. 4, (1999), pp. 721-744.
- [8] C. Cotrutz and L. Xing, "Segment-based dose optimization using a genetic

- algorithm," *Physics in Medicine & Biology*, Vol. 48, No. 18, (2003), p. 2987.
- [9] D. Nguyen, D. O'Connor, D. Ruan, and K. Sheng, "Deterministic direct aperture optimization using multiphase piecewise constant segmentation," *Medical physics*, Vol. 44, No. 11, (2017), pp. 5596-5609.
- [10] X. Zeng, H. Gao, and X. Wei, "Rapid direct aperture optimization via dose influence matrix based piecewise aperture dose model," *Plos one*, Vol. 13, No. 5, (2018), p. e0197926.
- [11] H. E. Romeijn, R. K. Ahuja, J. F. Dempsey, and A. Kumar, "A column generation approach to radiation therapy treatment planning using aperture modulation," *SIAM Journal on Optimization*, Vol. 15, No. 3, (2005), pp. 838-862.
- [12] C. Men, X. Jia, and S. B. Jiang, "GPU-based ultra-fast direct aperture optimization for online adaptive radiation therapy," *Physics in Medicine & Biology*, Vol. 55, No. 15, (2010), p. 4309.
- [13] D. M. Shepard, M. A. Earl, X. A. Li, S. Naqvi, and C. Yu, "Direct aperture optimization: a turnkey solution for step and shoot IMRT," *Medical physics*, Vol. 29, No. 6, (2002), pp. 1007-1018.
- [14] R. Cao, X. Pei, H. Zheng, L. Hu, and Y. Wu, "Direct aperture optimization based on genetic algorithm and conjugate gradient in intensity modulated radiation therapy," *Chinese medical journal*, Vol. 127, No. 23, (2014), pp. 4152-4153.
- [15] C. Bingzhou, C. Zhang, T. Zhiquan, and H. Qing, "A genetic algorithm used for the intensity level discretization in MLC leaf sequencing for step and shoot IMRT," *Nuclear Science and Techniques*, Vol. 19, No. 1, (2008), pp. 22-31.
- [16] M. MacFarlane, D. A. Hoover, E. Wong, P. Goldman, J. J. Battista, and J. Z. Chen, "A fast inverse direct aperture optimization algorithm for intensity modulated radiation therapy," *Medical Physics*, Vol. 46, No. 3, (2019), pp. 1127-1139.
- [17] D. A. Ripsman, T. G. Purdie, T. C. Chan, and H. Mahmoudzadeh, "Robust Direct Aperture Optimization for Radiation Therapy Treatment Planning," *arXiv preprint arXiv:2111.04847*, (2021).
- [18] L. P. Cáceres, I. Araya, and G. Cabrera-Guerrero, "Stochastic Local Search for the Direct Aperture Optimisation Problem," *Expert Systems with Applications*, Vol. 182, (2021), p. 115206.
- [19] M. Mahnam, M. Gendreau, N. Lahrichi, and L.-M. Rousseau, "Integrating DVH criteria into a column generation algorithm for VMAT treatment planning," *Physics in Medicine & Biology*, Vol. 64, No. 8, (2019), p. 085008.
- [20] M. Witten and O. Clancey, "Population-Based Metaheuristic Approximation For Dosimetric Optimization in CyberKnife Radiation Therapy Treatment Planning," *International Journal of Radiation Oncology, Biology, Physics*, Vol. 81, No. 2, (2011), p. S851.
- [21] A. Holder and B. Salter, "A tutorial on radiation oncology and optimization," *Tutorials on emerging methodologies and applications in operations research*, (2005), pp. 4-1-4-45.
- [22] A. Sadeghnejad Barkousaraie, O. Ogunmolu, S. Jiang, and D. Nguyen, "A fast deep learning approach for beam orientation optimization for prostate cancer treated with intensity modulated radiation therapy," *Medical physics*, Vol. 47, No. 3, (2020), pp. 880-897.
- [23] M. Mahnam, M. Gendreau, N. Lahrichi, and L.-M. Rousseau, "Simultaneous delivery time and aperture shape optimization for the volumetric-modulated arc therapy (VMAT) treatment planning problem," *Physics in Medicine & Biology*, Vol. 62, No. 14, (2017), p. 5589.
- [24] S. Das and P. N. Suganthan, "Differential evolution: A survey of the state-of-the-

- art," *IEEE transactions on evolutionary computation*, Vol. 15, No. 1, (2010), pp. 4-31.
- [25] D. Wang, D. Tan, and L. Liu, "Particle swarm optimization algorithm: an overview," *Soft Computing*, Vol. 22, No. 2, (2018), pp. 387-408.
- [26] J. Kennedy and R. Eberhart, "Particle swarm optimization," in *Proceedings of ICNN'95-international conference on neural networks*, Vol. 4: IEEE, (1995), pp. 1942-1948.
- [27] S. Sengupta, S. Basak, and R. A. Peters, "Particle Swarm Optimization: A survey of historical and recent developments with hybridization perspectives," *Machine Learning and Knowledge Extraction*, Vol. 1, No. 1, (2019), pp. 157-191.
- [28] E. H. Houssein, A. G. Gad, K. Hussain, and P. N. Suganthan, "Major advances in particle swarm optimization: theory, analysis, and application," *Swarm and Evolutionary Computation*, Vol. 63, (2021), p. 100868.
- [29] M. Mahnam and S. M. T. Fatemi Ghomi, "Time Variant Fuzzy Time Series Approach for Forecasting Using Particle Swarm Optimization," (in eng), *International Journal of Industrial Engineering & Production Research*, Research Vol. 23, No. 4, (2012), pp. 269-276.
- [30] S. Jafarian-Namin, m. s. Fallahnezhad, R. Tavakkoli-Moghaddam, A. Salmasnia, and M. H. Abooei, "A Comparative Study on a Triple-Concept Model of Two Techniques for Monitoring the Mean of Stationary Processes," (in eng), *International Journal of Industrial Engineering & Production Research*, Research Vol. 32, No. 4, (2021), pp. 1-18.
- [31] G. Moslehi and M. Mahnam, "A Pareto approach to multi-objective flexible job-shop scheduling problem using particle swarm optimization and local search," *International Journal of Production Economics*, Vol. 129, No. 1, (2011), pp. 14-22.
- [32] R. Storn and K. Price, "Differential evolution—a simple and efficient heuristic for global optimization over continuous spaces," *Journal of global optimization*, Vol. 11, No. 4, (1997), pp. 341-359.
- [33] M. Pant, H. Zaheer, L. Garcia-Hernandez, and A. Abraham, "Differential Evolution: A review of more than two decades of research," *Engineering Applications of Artificial Intelligence*, Vol. 90, (2020), p. 103479.
- [34] K. R. Opara and J. Arabas, "Differential Evolution: A survey of theoretical analyses," *Swarm and evolutionary computation*, Vol. 44, (2019), pp. 546-558.
- [35] H. Mokhtari and A. Mozdgir, "A Bi-Objective Approach to an Assembly Line Re-Balancing Problem: Model and Differential Evolution Algorithms," *International Journal of Industrial Engineering & Production Research*, Vol. 26, No. 2, (2015), pp. 105-117.
- [36] A. Fallahi, H. Mokhtari, and S. T. A. Niaki, "Designing a Closed-Loop Blood Supply Chain Network Considering Transportation Flow and Quality Aspects," *Sustainable Operations and Computers*, (2021).
- [37] A. Homaifar, C. X. Qi, and S. H. Lai, "Constrained optimization via genetic algorithms," *Simulation*, Vol. 62, No. 4, (1994), pp. 242-253.
- [38] E. Mezura-Montes and C. A. C. Coello, "Constraint-handling in nature-inspired numerical optimization: past, present and future," *Swarm and Evolutionary Computation*, Vol. 1, No. 4, (2011), pp. 173-194.
- [39] S. Breedveld and B. Heijmen, "Data for TROTS—the radiotherapy optimisation test set," *Data in brief*, Vol. 12, (2017), pp. 143-149.

Follow This Article at The Following Site:

Fallahi A, Mahnam M, Akhavan Niaki S T. Direct Aperture Optimization for Intensity Modulated Radiation Therapy: Two Calibrated Metaheuristics and Liver Cancer Case Study. IJIEPR. 2022; 33 (2) :1-14

URL: <http://ijiepr.iust.ac.ir/article-1-1445-en.html>

